

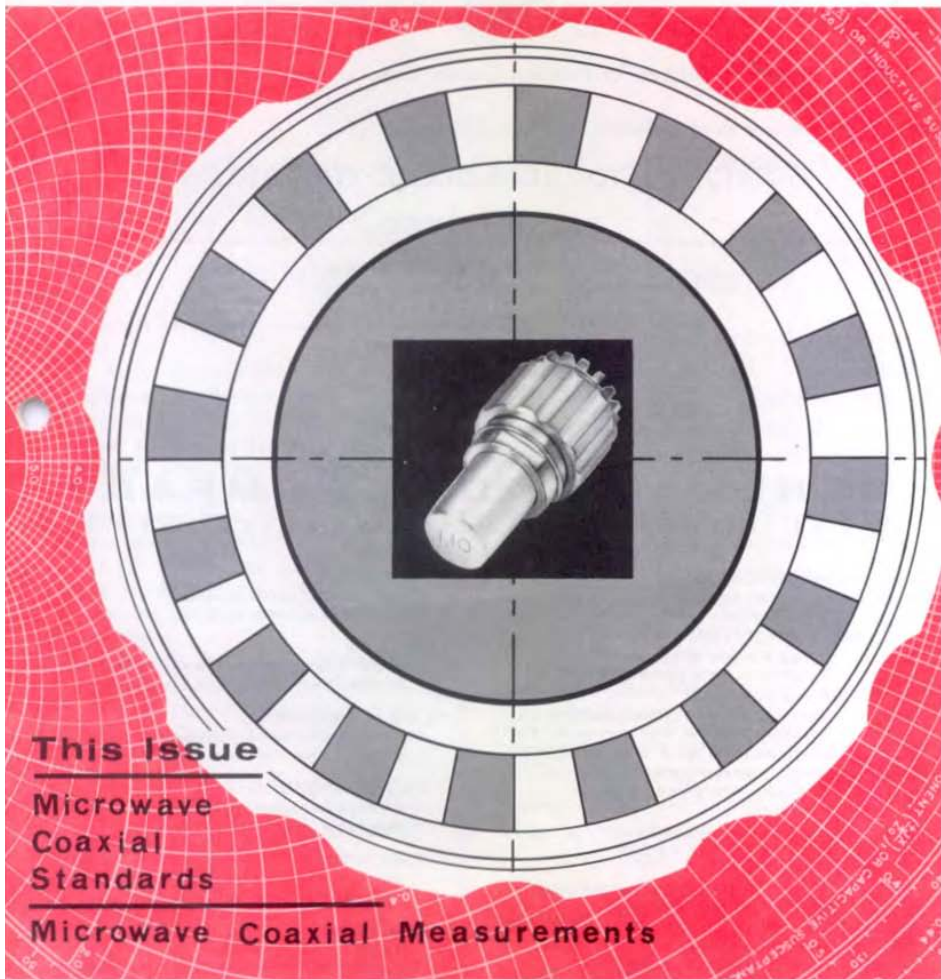

THE GENERAL RADIO

# Experimenter



## This Issue

Microwave  
Coaxial  
Standards

Microwave Coaxial Measurements

VOLUME 40 · NUMBER 5 / MAY 1966



IET LABS, INC in the GenRad tradition  
534 Main Street, Westbury, NY 11590

www.ietlabs.com  
TEL: (516) 334-5959 • (800) 899-8438 • FAX: (516) 334-5988

# the Experimenter

© 1966 — General Radio Company, West Concord, Mass., USA

Published monthly by the General Radio Company

## THIS ISSUE

	Page
Calibration Standards for Precision Coaxial Lines.....	3
Measurements of Dielectric Materials with the Precision Slotted Line.....	12

## GENERAL RADIO COMPANY

West Concord, Massachusetts 01781

\* **NEW ENGLAND**

22 Baker Avenue  
West Concord, Massachusetts 01781

\* **METROPOLITAN NEW YORK**

Broad Avenue at Linden  
Ridgefield, New Jersey 07657

**PHILADELPHIA**

Fort Washington Industrial Park  
Fort Washington, Pennsylvania 19034

\* **WASHINGTON and BALTIMORE**

11420 Rockville Pike  
Rockville, Maryland 20852

**ORLANDO**

113 East Colonial Drive  
Orlando, Florida 32801

**SYRACUSE**

Pickard Building, East Molloy Rd.  
Syracuse, New York 13211

**CLEVELAND**

5579 Pearl Road  
Cleveland, Ohio 44129

\* **CHICAGO**

6605 West North Avenue  
Oak Park, Illinois 60302

\* **DALLAS**

2600 Stemmons Freeway, Suite 210  
Dallas, Texas 75207

\* **LOS ANGELES**

1000 North Seward Street  
Los Angeles, California 90038

**SAN FRANCISCO**

626 San Antonio Road  
Mountain View, California 94040

\* **TORONTO**

99 Floral Parkway  
Toronto 15, Ontario, Canada

**MONTREAL**

1255 Laird Boulevard  
Town of Mt. Royal, Quebec, Canada

\* Repair services are available at these offices

GENERAL RADIO COMPANY (OVERSEAS), 8008 Zurich, Switzerland

GENERAL RADIO COMPANY (U.K.) LIMITED, Bourne End, Buckinghamshire, England

REPRESENTATIVES IN PRINCIPAL OVERSEAS COUNTRIES



**IET LABS, INC** in the **GenRad** tradition

534 Main Street, Westbury, NY 11590

www.ietlabs.com

TEL: (516) 334-5959 • (800) 899-8438 • FAX: (516) 334-5988



Figure 1. View of the terminations described in this article.

## Calibration Standards for Precision Coaxial Lines

### TYPE 900-WR STANDARD MISMATCHES

In a coaxial line, as in any uniform, distributed-parameter system, it is the terminating impedance that determines the reflection that occurs when an electromagnetic wave traveling down the line reaches the far end. From the magnitude and phase of the reflection, the nature of the terminating impedance can be deduced, and coaxial-line measurement devices are based on this principle.

As with any measuring system, standards of calibration are necessary to ensure accuracy of measurement. The standard terminations described here fill this need and are recommended for the calibration of slotted lines, bridges, impedance plotters, fixed- and swept-frequency reflectometers, and time-domain reflectometers.

These broadband mismatches are standards of *vswr*, for use in the calibration of slotted-line systems, reflectometers, and other *vswr* and

reflection-coefficient measuring devices. The TYPES 900-WR110, -WR120 and -WR150 Standard Mismatches introduce *vswr*'s of 1.1, 1.2, and 1.5, respectively, and each of these units exhibits nearly uniform *vswr* characteristics from dc to 8.5 GHz. (See Figure 2.) Each unit comprises a 50.0-ohm GR900 Precision Coaxial Connector, a low-reflection continuous transition, and a precision cylindrical resistor. The position at which the mismatch is introduced into the 50.0-ohm system is approximately 4 cm behind the reference plane of the GR900 Connector.

The terminating elements are highly stable, deposited-metal-film resistors with dc resistances of 45.45, 41.67 and 33.33 ohms, respectively,  $\pm 0.3\%$ . Calibration charts supplied with each unit give the measured resistance at dc and at five points in the frequency band. NBS calibration services are also available to 4 GHz with uncertainties of *vswr* measurement from  $\pm 0.005$  at 1 GHz to  $\pm 0.010$  at 4 GHz.



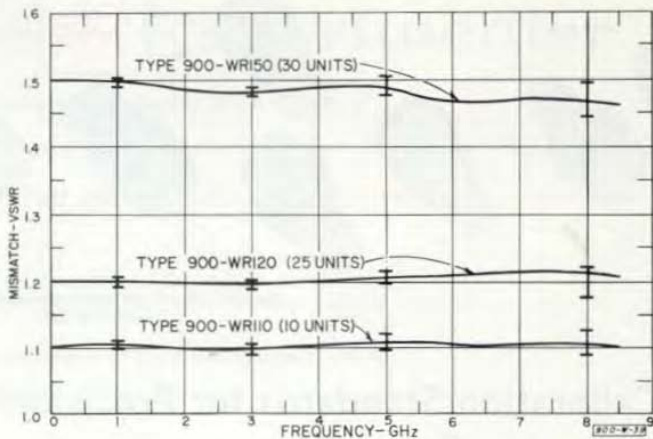

Figure 2. Average mismatch VSWR of sample lots. Spreads in the measured data are shown at 1, 3, 5, and 8 GHz. Measurement accuracy is better than  $\pm 0.003$  for the Type 900-WR110,  $\pm 0.005$  for the Type 900-WR120, and  $\pm 0.010$  for the Type 900-WR150.

### APPLICATIONS

#### Direct RF Calibration of Slotted-Line Systems

Many factors contribute to inaccuracy in the measurement of vswr with a slotted-line system. Uncertainty in the detector response law, calibration accuracy of the indicating instrument, residual vswr and probe reflections in the slotted line — all of these introduce varying effects that are dependent on the magnitude of vswr being measured, the frequency of operation, and the nature of the instruments. The TYPE 900-WR Standard Mismatches offer a simple means of establishing directly, at the measurement frequency, the over-all system accuracy.

Figure 3 shows the standing-wave patterns of design-center mismatches at vswr levels of 1.1 and 1.2, measured at 7 GHz with the TYPE 1640-A Slotted Line Recording System.<sup>1</sup>

<sup>1</sup>A. E. Sanderson, "A Slotted Line Recorder System," "Reference Air Lines for the GR900 Series," and "New Coaxial Tuner with Neutral Setting," *General Radio Experimenter*, January 1965.

#### Calibration of Frequency-Domain Reflectometers

The TYPE 900-WR Standard Mismatches are well suited for the vswr calibration of swept-frequency reflectometers and impedance plotters based on directional couplers, hybrid junctions, magic tees, or rf bridges. Calibration through GR900 Connectors offers the greatest accuracy; however, the use of the TYPE 900-Q Adaptors makes it possible to calibrate measuring devices

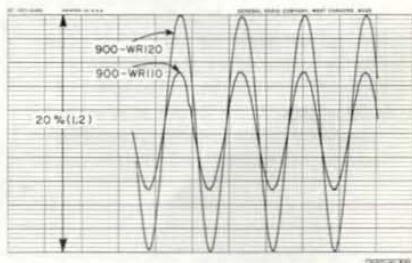

Figure 3. Standing-wave patterns of Types 900-WR110 and -WR120 Standard Mismatches as measured at 7GHz with a Type 1640-A Slotted Line Recording System.

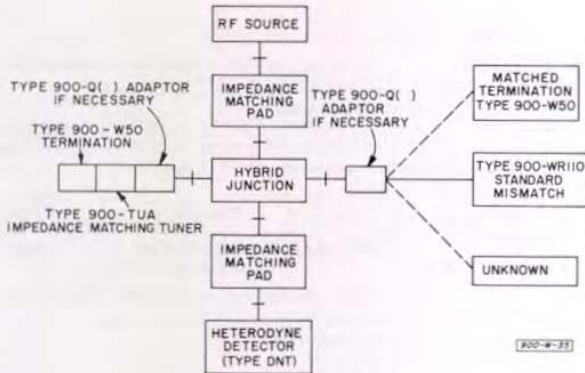

Figure 4. Fixed-frequency reflectometer for measuring VSWR's below 1.1.

equipped with many other types of connectors.

The TYPE 900-WR110 Mismatch is particularly useful for the calibration of fixed-frequency reflectometers where the residual reflection errors of the measuring instruments are tuned out. As an example, Figure 4 is the block diagram of a fixed-frequency reflectometer system built around a hybrid junction in which the error signal is proportional to the reflection coefficient of the unknown being measured. This system provides full-scale vswr indications of 10%, 1%, and even 0.1%.\*

The calibration procedure for this system is as follows:

(a) A TYPE 900-W50 Standard Termination is connected to the unknown port of the hybrid junction and the impedance-matching tuner (TYPE 900-TUA<sup>1</sup>) is adjusted for a null in the detected signal. This makes the instrument residual reflection equal in magni-

tude to the residual reflection of the termination. Thus, the accuracy of the measurement is directly dependent on the accuracy of the termination. (Highly accurate calibration techniques for determining the termination accuracy are described by Sanderson.<sup>2</sup>)

(b) The TYPE 900-WR110 Standard Mismatch (vswr = 10%) is connected in place of the matched termination, and the signal level is adjusted for full-scale indication on the meter of the TYPE 1216-A Unit I-F Amplifier in the TYPE DNT Detector.

The unknown to be measured is now connected in place of the standard mismatch, and its vswr is read directly from the linear scale of the i-f amplifier meter. If the setting of the amplifier attenuator switch is reduced by 20 dB, the full-scale vswr becomes 1%, and, for 40-dB reduction, the full-scale vswr becomes 0.1%. The assumption that the linear scales apply is not rigorously true, since the relationship between vswr and reflection coefficient is not a linear one. However, for vswr's up to 10%, the error is less than 1/20<sup>th</sup> of the indicated vswr in percent.

\* VSWR in percent is given by  $(VSWR - 1) \times 100$ .

<sup>1</sup> *Ibid.*

<sup>2</sup> Sanderson, A. E., "Calibration Techniques for One- and Two-Port Devices Using Coaxial Reference Air Lines as Absolute Impedance Standards," presented at the ISA 19th Annual Conference and Exhibit, 1964; available from General Radio Company as Technical Publication B-21.

### SPECIFICATIONS

#### TYPE 900-WR110 STANDARD MISMATCH

**Frequency Range:** DC to 8.5 GHz.

**Mismatch VSWR**

*Up to 1 GHz:*  $1.1000 \pm (0.0055 + 0.0110 f_{GHz})$ .

*1 to 8.5 GHz:*  $1.1000 \pm (0.0115 + 0.0050 f_{GHz})$ .

**DC Resistance:**  $45.45 \Omega \pm 0.3\%$ .

**Leakage:** Better than 130 dB below signal.

**Maximum Power:** 1 W with negligible change; 5 W without damage.

**Temperature Coefficient:** Less than 150 ppm/°C.

**Dimensions:** Length, 2 in (51 mm); maximum diameter,  $1\frac{1}{16}$  in (27 mm).

**Net Weight:**  $3\frac{1}{2}$  oz (100 g).

Catalog Number	Description	Price in USA
0900-9961	<b>Type 900-WR110 Standard Mismatch</b>	<b>\$60.00</b>

#### TYPE 900-WR120 STANDARD MISMATCH

Same as Type 900-WR110 except:

**Mismatch VSWR**

*Up to 1 GHz:*  $1.2000 \pm (0.0060 + 0.0120 f_{GHz})$ .

*1 to 8.5 GHz:*  $1.2000 \pm (0.0125 + 0.0055 f_{GHz})$ .

**DC Resistance:**  $41.67 \Omega \pm 0.3\%$ .

Catalog Number	Description	Price in USA
0900-9963	<b>Type 900-WR120 Standard Mismatch</b>	<b>\$60.00</b>

#### TYPE 900-WR150 STANDARD MISMATCH

Same as Type 900-WR110 except:

**Mismatch VSWR**

*Up to 1 GHz:*  $1.5000 \pm (0.0075 + 0.0150 f_{GHz})$ .

*1 to 8.5 GHz:*  $1.5000 \pm (0.0155 + 0.0070 f_{GHz})$ .

**DC Resistance:**  $33.33 \Omega \pm 0.3\%$ .

Catalog Number	Description	Price in USA
0900-9965	<b>Type 900-WR150 Standard Mismatch</b>	<b>\$60.00</b>

### TYPE 900-W STANDARD TERMINATIONS

These broadband resistive terminations are standards of impedance, which can be used to calibrate swept-frequency impedance-measuring systems, impedance plotters, slotted-line systems, bridges and time-domain reflectometers.

In contrast to the TYPE 900-WR Standard Mismatches, the Standard Terminations are calibrated in phase as well as magnitude; that is, the position of the standard resistance with respect to a reference point in the connector is accurately known. These

terminations, therefore, find their greatest use in the calibration of impedance-measuring systems, although they are also standards of vswr.

The TYPES 900-W100 and -W200 Standard Terminations are 100- and 200-ohm terminating resistances for a 50.0-ohm system. The resistances introduced remain very nearly equal to their dc resistances over the frequency band from dc to 8.5 GHz, as illustrated in Figure 5. These units are similar in construction to the TYPE 900-WR Standard Mismatches.

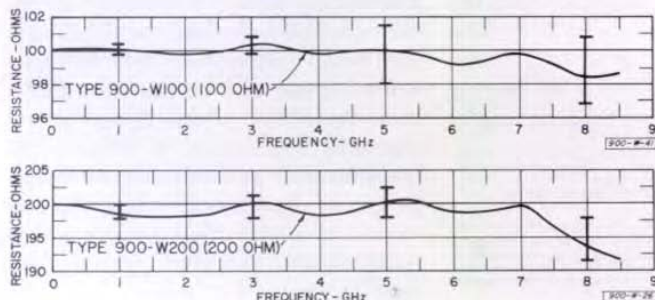

Figure 5. Average resistance of 25 units each of Type 900-W100 and Type 900-W200. Spreads in the measured data are shown at 1, 3, 5, and 8 GHz. Measurement accuracy is better than 1%.



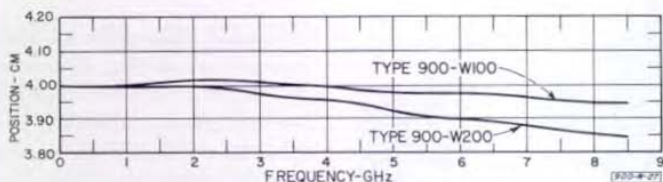

Figure 6a. Average position behind GR900 Connector reference plane at which resistance is applied for the units of Figure 5.

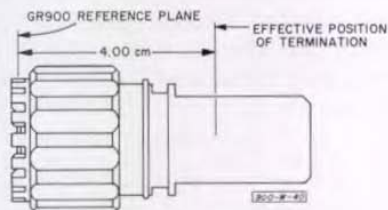

Figure 6b. Sketch showing relation of termination position and reference plane.

The reference plane at which the termination is introduced into the 50.0-ohm system is 4 cm behind the reference plane of the GR900 Connector, as shown in Figure 6. Calibration charts supplied with each unit include measured data on the position at which the resistance effectively appears in addition to the measured resistance at dc and at 5 points in the frequency band.

APPLICATIONS

Calibration of Slotted-Line and Reflectometer Systems

The TYPE 900-W Standard Terminations, like the TYPE 900-WR Standard Mismatches, are used to perform direct rf calibration of slotted-line systems. At the 100-ohm and 200-ohm levels (mismatches of 2 and 4, respectively), the errors introduced by variations in the detector-response law, uncertainties in the indicator calibration, and, most important, probe reflections in the slotted line can be appreciable. The TYPE 900-W Terminations permit a rapid, yet accurate, test of a system's performance, without the necessity of time-consuming check-out procedures.

Similarly, with reflectometer systems, these standard terminations provide important calibration points. Since the terminations are calibrated in both magnitude and phase, they are most useful in the calibration of complex reflection-coefficient measuring instruments such as automatic impedance plotters. Because of the phase calibration of the terminations, they can be combined with sections of precision air line to produce many known complex impedances. For example, a TYPE 900-W100 Termination in combination with a 6-cm air line produces (at the air-line input connector mating plane) an impedance of 40.0 - j30.0 ohms at frequencies given by

$$3 \left( \frac{1 + 4n}{8} \right) \text{ GHz and } 40.0 + j30.0 \text{ ohms}$$

$$\text{at frequencies given by } 3 \left( \frac{3 + 4n}{8} \right) \text{ GHz,}$$

where n is zero or a positive integer. The TYPE 900-L Precision Air Lines and the TYPE 900-LZ Reference Air Lines<sup>1</sup> are recommended for such applications.

<sup>1</sup>Ibid.



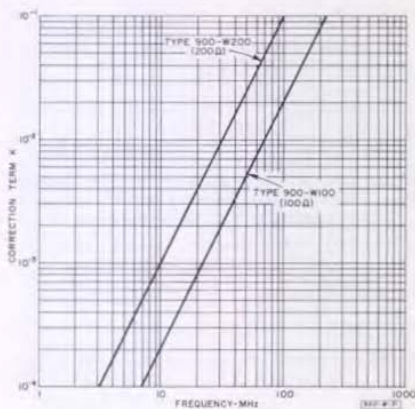

Figure 7. Correction term, K, for the 4-cm difference between the GR900 Connector reference plane and the effective position of the resistance.

### Calibration of Bridges

The TYPE 900-W Standard Terminations are used to calibrate bridges in much the same manner as described for slotted lines and reflectometers. For some bridges, the termination reference plane 4 cm away from the GR900

Connector mating plane may not be the most convenient reference plane to use. Below about 200 MHz, however, the resistive component of the impedance presented at the connector reference plane departs only slightly from that presented at the 4-cm reference position. This resistance (at the GR900 Connector reference plane) is given as a function of frequency, approximately, by:

$$R' = R \left[ 1 - \left( \tan^2 \frac{4\pi f}{15} \right) \left( \left[ \frac{R}{50} \right]^2 - 1 \right) \right]$$

$$= R(1 - K)$$

where  $R$  is the calibrated dc resistance of the termination in question and  $f$  is the frequency in GHz.

The correction term

$$K = \left( \tan^2 \frac{4\pi f}{15} \right) \left( \left[ \frac{R}{50} \right]^2 - 1 \right)$$

is a result of the distributed capacitance of the 4-cm length of line between the two reference planes and is plotted in Figure 7 for resistances of 100 and 200 ohms.

## SPECIFICATIONS

### TYPE 900-W100 100-OHM STANDARD TERMINATION

**Frequency Range:** DC to 8.5 GHz.  
**DC Resistance:**  $100 \Omega \pm 0.3\%$ .  
**RF Resistance**  
*Up to 1 GHz:*  $100.00 \pm (0.50 + 1.00 f_{GHz})$   
*1 to 8.5 GHz:*  $100.00 \pm (1.05 + 0.45 f_{GHz})$   
**Position at Which Resistance Specification Applies**  
*Up to 2 GHz:* (4.00  $\pm$  0.05) cm beyond the GR900 Connector reference plane.  
*2 to 8.5 GHz:* (4.02 - 0.01  $f_{GHz} \pm 0.05$ ) cm beyond the GR900 Connector reference plane.  
**Leakage:** Better than 130 dB below signal.  
**Maximum Power:** 1 W with negligible change; 5 W without damage.  
**Temperature Coefficient:** Less than 150 ppm/ $^{\circ}C$ .  
**Dimensions:** Length, 2 in (51 mm); maximum diameter,  $1\frac{1}{8}$  in (27 mm).  
**Net Weight:**  $3\frac{1}{2}$  oz (100 g).

Catalog Number	Description	Price in USA
0900-9957	Type 900-W100 100-Ohm Standard Termination	\$60.00

### TYPE 900-W200 200-OHM STANDARD TERMINATION

Same as Type 900-W100, except:  
**DC Resistance:**  $200 \Omega \pm 0.3\%$ .  
**RF Resistance**  
*Up to 1 GHz:*  $200.00 \pm (1.00 + 2.00 f_{GHz})$   
*1 to 7 GHz:*  $200.00 \pm (2.10 + 0.90 f_{GHz}) + 8.40$   
*7 to 8.5 GHz:* 200.00 or  $-(8.40 + 7.20 [f_{GHz} - 7])$   
**Position at Which Resistance Specification Applies**  
*Up to 2 GHz:* (4.00  $\pm$  0.05) cm beyond the GR900 Connector reference plane.  
*2 to 8.5 GHz:* (4.04 - 0.02  $f_{GHz} \pm 0.05$ ) cm beyond the GR900 Connector reference plane.

Catalog Number	Description	Price in USA
0900-9959	Type 900-W200 200-Ohm Standard Termination	\$60.00



## TYPE 900-WN4 PRECISION SHORT-CIRCUIT TERMINATION

The TYPE 900-WN4 Short-Circuit Termination presents a low-loss short circuit 4.00 cm beyond the reference plane of its GR900 Connector reference plane. The reflection coefficient introduced at the actual short-circuit plane is greater than 0.999, and that introduced at the connector reference plane is greater than 0.996.

### APPLICATIONS

This short circuit is used with the TYPE 900-WO4 Precision Open-Circuit Termination (described below) to establish short- and open-circuit reference planes coincident within 0.02 cm over the frequency range from dc to 8.5 GHz. The reference planes so established are useful in direct impedance measurements, in loss measurements based on reflection measurements, in the calibration of reflection-coefficient measuring instruments, and, generally, in the measurement of the scattering coefficients of multiport coaxial devices.

Since its 4.00-cm reference plane coincides with those of the TYPES 900-W100 and -W200 Standard Terminations, the TYPE 900-WN4 can be used in conjunction with these terminations for the calibration of bridges, slotted-line systems, etc.

Figure 8 illustrates the calibration levels obtainable with the TYPES 900-

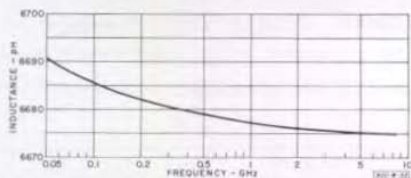

Figure 9. Inductance presented at the GR900 Connector reference plane of the Type 900-WN4 Precision Short-Circuit Termination.

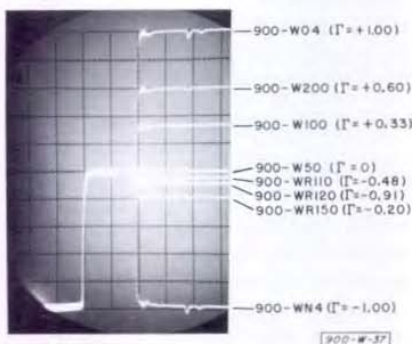

Figure 8. Multiple exposure of time-domain reflectometer traces for the various GR900 terminations at the end of a length of 50-ohm air line.

WR, 900-W, 900-WN4 and 900-WO4 Standards. All these units are recommended for the calibration of time-domain-reflectometry systems.

Since the TYPE 900-WN4 comprises a single section of uniform transmission line with no disturbances or dielectric supports between the short circuit and the connector reference plane, it is a calculable inductance standard of high accuracy. This is particularly true at frequencies above about 50 MHz, where the current flows primarily in the silver overlays on the conductive surfaces. Figure 9 is a plot of the calculated inductance at the connector reference plane for frequencies above 50 MHz based on a conductor resistivity of 1.7 microhm-cm, which is typical for the conductors of the TYPE 900-WN4.

### SPECIFICATIONS

#### TYPE 900-WN4 PRECISION SHORT-CIRCUIT TERMINATION

**Frequency Range:** DC to 8.5 GHz.  
**Reflection Coefficient:** Greater than 0.996 at the GR900 Connector reference plane.  
**Location of Short Circuit:**  $4.00 \pm 0.01$  cm beyond the GR900 Connector reference plane.



**Characteristic Impedance of Internal Coaxial Line:**  $50.0 \Omega \pm 0.065\%$  at frequencies where skin effect is negligible.

**Leakage:** Better than 130 dB below signal.

**Dimensions:** Length, 2 in (51 mm); maximum diameter,  $1\frac{1}{16}$  in (27 mm).

**Net Weight:** 4 oz (120 g).

Catalog Number	Description	Price in USA
0900-9975	Type 900-WN4 Precision Short-Circuit Termination	\$40.00

## TYPE 900-WO4 PRECISION OPEN-CIRCUIT TERMINATION

The TYPE 900-WO4 presents an open circuit 4.0 cm beyond the GR900 Connector reference plane over the full dc-to-8.5-GHz frequency range, as illustrated in Figure 10. Compensation for the frequency-dependent fringing capacitance of the open-ended inner conductor is accomplished by means of a small disk on the inner conductor tip.

### APPLICATIONS

As a capacitance standard, the TYPE 900-WO4 presents a capacitance at its connector reference plane that is given approximately by

$$C = C_o \left[ 1 + \left( \frac{\tan \frac{4\pi f}{15}}{\frac{4\pi f}{15}} - 1 \right) \right]$$

$$= C_o (1 + K)$$

where the capacitance  $C_o$  is a result of the 4-cm length of line between the effective open-circuit reference plane and the connector reference plane and  $f$  is the frequency in GHz. The capacitance  $C_o$  has a nominal value of 2.673 picofarads. The correction term

$$K = \frac{\tan \frac{4\pi f}{15}}{\frac{4\pi f}{15}} - 1$$

**Figure 10.** Average position behind GR900 Connector reference plane at which open circuit is applied. Data are based on 25 units. Spreads are shown at 2.5, 5.5, and 8.5 GHz.

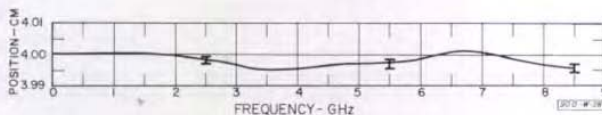

is a result of the distributed nature of the capacitance, which has an appreciable effect at frequencies above 70 MHz. The correction term  $K$  is plotted in Figure 11.

As an open-circuit termination for the TYPE 900-LZ Reference Air Lines, the TYPE 900-WO4 provides support for the inner conductors of the air lines. Since the effective reference plane of the TYPE 900-WO4 Open Circuit is coincident with that of the TYPE 900-WN4 Short Circuit, these two units, alone or in conjunction with the TYPE 900-LZ Reference Air Lines, form a series of accurate conjugate-reactance standards, which can be used in the calibration of impedance-measuring devices. Further, the reference plane of the TYPE 900-WO4 is coincident with those of the TYPES 900-W100 and -W200 Terminations within 0.06 cm to 2 GHz and within 0.20 cm to 8.5 GHz.

Combinations of the TYPE 900-WO4 Open-Circuit and the TYPE 900-LZ Air Lines also make an accurate series of incremental capacitance standards for use at audio and at the lower radio frequencies. Fringing capacitance at

the measuring-instrument terminals is eliminated when the TYPE 900-WO4 is used to establish the initial conditions. The agreement between calculated capacitance and measured capacitance at 1 kHz for a 10-picofarad (15 cm) TYPE 900-LZ15 Reference Air Line is better than 0.05%. The GR900 Connector repeatability at 1 kHz is better than 0.001 picofarad.

— T. E. MACKENZIE



Thomas E. MacKenzie received his BSEE and MS in Physics in 1958 and 1963, respectively, from Northeastern University. From 1954 to 1962, he was an engineer at Alford Manufacturing Company. As a development engineer in the Microwave Group at General Radio since 1962, his work has been in the development of microwave instruments, components, and standards.

## SPECIFICATIONS

### TYPE 900-WO4 PRECISION OPEN-CIRCUIT TERMINATION

**Frequency Range:** DC to 8.5 GHz.

**Reflection Coefficient:** Greater than 0.996 at the GR900 Connector Reference Plane.

**Location of Open Circuit:**  $4.00 \pm 0.01$  cm beyond the GR900 Connector reference plane.

**Capacitance at GR900 Connector Reference Plane:**  $2.673 \text{ pF} \pm 0.3\%$ , dc to 70 MHz.

**Characteristic Impedance of Internal Coaxial Line:**  $50.0 \Omega \pm 0.1\%$  at frequencies where skin effect is negligible.

**Leakage:** Better than 130 dB below signal.

**Dimensions:** Length,  $2\frac{5}{16}$  in (59 mm); maximum diameter,  $1\frac{1}{16}$  in (27 mm).

**Net Weight:** 4 oz (120 g).

Catalog Number	Description	Price in USA
0900-9985	Type 900-WO4 Precision Open-Circuit Termination	\$40.00

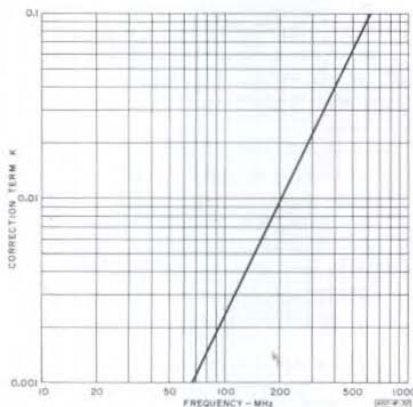

Figure 11. Correction term, K, for Type 900-WO4 Open-Circuit Termination.

## Publications

PULSES — Instrument Note IN-108, "Generation and Detection of Modulated Pulses," by Dr. Gordon R. Partridge, of GR's Development Engineering Department, discusses the characteristics of pulse-position, pulse-

amplitude, pulse-duration, and pulse-code modulation and describes equipment and methods for their generation and detection.

Reprints are also available of recent technical articles by GR engineers:

Number	Author	Title	Published in
A123	W. G. Howard	"Simple Methods of Voltage-to-Frequency Conversion"	<i>Frequency</i> , September/October, 1964
A124	H. T. McAleer	"Unique Frequency Multiplier"	<i>Frequency</i> , May/June, 1964
A126	A. E. Sanderson	"How to Measure Source Impedance with a Slotted Line"	<i>EEE</i> , November, 1965



## Measurements of Dielectric Materials with the Precision Slotted Line

The slotted line has long been recognized as a fundamental tool for measuring the dielectric properties of materials at high frequencies. In principle, the measuring technique is simple: fill a section of coaxial line with dielectric material, determine the propagation constant of the filled section of line from the phase and magnitude of the reflection introduced, as determined by measurement of standing-wave ratio on the slotted line, and calculate the dielectric constant and loss tangent from the propagation constant.

For valid measurements, there are needed (1) an accurate slotted line, (2) sections of air line usable as sample holders, and (3) low-reflection, low-loss, coaxial connectors. These are all now available in the GR900 series, and the accompanying article tells how to use them.

The low and repeatable *v*SWR and the low loss of the GR900 Precision Coaxial Connector make possible the use of GR900 equipment for the accurate determination of dielectric constant and loss tangent. No specialized dielectric measuring apparatus is necessary.

The measuring device is the TYPE 900-LB Precision Slotted Line.<sup>1</sup> The combination of a TYPE 900-LZ Reference Air Line<sup>2</sup> and a TYPE 900-WNC Short Circuit makes a convenient sam-

ple holder for solid dielectrics. The error introduced by the inclusion of the GR900 Connector between the sample and the point of measurement is negligible for most purposes.

The dimensions for a cylindrical sample of solid dielectric are shown in Figure 1. The total length of the sample may be made up of a number of pieces and may be equal to or less than the length of the sample holder. There should be no gaps between the individual pieces. The accuracy of the measurements will depend upon the precision with which the diameters are machined. A light press fit of the sample against the inner and outer conductors is desirable, but too tight a fit may damage the TYPE 900-LZ Reference Air Line. For accurate loss-tangent measurements of a very low-loss material, the length of the sample should be selected by the procedure described below under *Effect of Contact Resistance*.

Standard lengths of TYPE 900-LZ Reference Air Lines (5 cm, 6 cm, 7.5 cm, 10 cm, 15 cm, 30 cm) will meet most needs. If other lengths are needed, they can be constructed from TYPE 0900-9508 rod, TYPE 0900-9509 tube, and TYPE 900-AP Connector Kits.

### THEORY

The measurements that will be considered here are those of nonmagnetic materials in a short-circuited sample holder. Other types of measurements are described in various references.<sup>3</sup>

If a coaxial line containing a dielectric sample is short-circuited at its far

<sup>1</sup>J. Zorzy, "Precision Coaxial Equipment—The 900 Series," *General Radio Experimenter*, November 1963.

<sup>2</sup>A. E. Sanderson, "Reference Air Lines for the GR900 Series," *General Radio Experimenter*, January 1965.

<sup>3</sup>For example, A. von Hippel, *Dielectric Materials and Applications*, Technology Press of MIT, 1954.

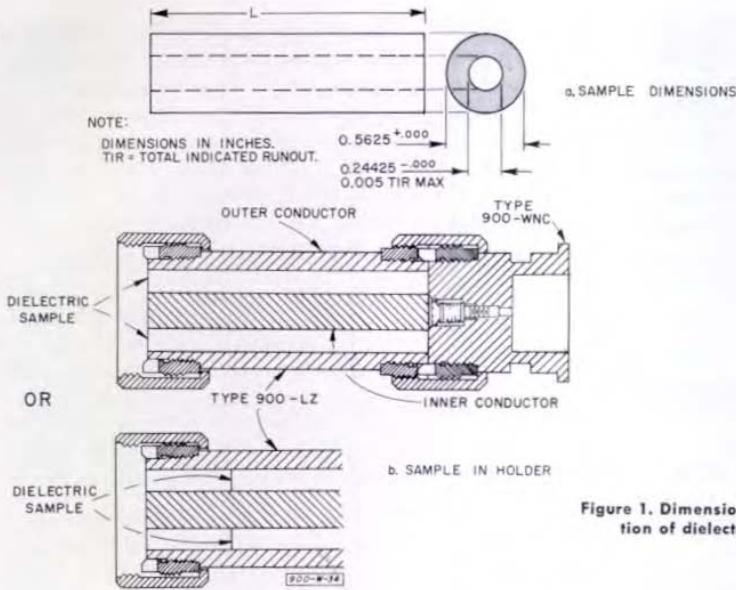

Figure 1. Dimensions and installation of dielectric sample.

end, the relationship between the propagation constant,  $\gamma$ , of the dielectric-filled line and the standing-wave ratio,  $S$ , and wavelength,  $\lambda_o$ , in an attached air-filled section of the line is:

$$\frac{\tanh \gamma d}{\gamma d} = \frac{\frac{1}{S} - j \tan \frac{2\pi X_o}{\lambda_o}}{1 - j \frac{1}{S} \tan \frac{2\pi X_o}{\lambda_o}} \frac{(-j) \lambda_o}{2\pi d} \quad (1)^4$$

where  $X_o$  = the distance from the face of the dielectric sample to the first voltage minimum in the air-filled line,  
 $d$  = the length of the sample,  
 $\lambda_o$  = the wavelength in the air-filled line,  
 $S$  = the standing-wave ratio in the air-filled line.

This equation can be separated into its real and imaginary parts and, if  $\tan \delta$  (the loss tangent) is less than 0.1, simplified with results accurate within

<sup>4</sup>T. W. Dakin and C. N. Works, "Microwave Dielectric Measurements," *Journal of Applied Physics*, September 1947, p 789.

$\pm 1\%$ . The simplified equations are:

$$\frac{\tan \beta d}{\beta d} = \frac{-\lambda_o \tan \frac{2\pi X_o}{\lambda_o}}{2\pi d} \quad (2)^4$$

where  $\beta$  = phase constant, and

$$\alpha d = \frac{\beta^2 d^2 \lambda_o}{2\pi d} \frac{1}{S} \frac{1 + \tan^2 \frac{2\pi X_o}{\lambda_o}}{\beta d (1 + \tan^2 \beta d) - \tan \beta d} \quad (3)^4$$

where  $\alpha$  = attenuation constant.

If the frequency and sample length are chosen so that  $X_o = 0$ , then  $\tan \beta d = 0$  and  $\beta d = N_s \pi$ , where  $N_s$  is the number of half wavelengths in the sample. The equation for  $\alpha d$  then becomes:

$$\alpha d = \frac{N_s \lambda_o}{2d} \frac{1}{S} \quad (4)$$

From a knowledge of  $\alpha$  and  $\beta$  in the dielectric-filled line, the relative dielectric constant,  $\epsilon_r$ , and the loss tangent,  $\tan \delta$ , can be calculated. For the TEM mode in a coaxial line:

$$\epsilon_r = \frac{\lambda_o^2}{4\pi^2} (\beta^2 - \alpha^2), \quad (5)$$

$$\text{and } \tan \delta = \frac{2\alpha\beta}{\beta^2 - \alpha^2}. \quad (6)$$

If  $\alpha^2$  is small compared with  $\beta^2$ , as is the case when  $\tan \delta$  is less than 0.1, equations (5) and (6) simplify, for samples that are an integral number of half-wavelengths long, to

$$\epsilon_r = \frac{\lambda_o^2 \beta^2}{4\pi^2} = \left( \frac{N_s \lambda_o}{2d} \right)^2, \quad (7)$$

$$\text{and } \tan \delta = \frac{2\alpha}{\beta} = \frac{\lambda_o}{\pi d} \frac{1}{S}. \quad (8)$$

For small values of  $\frac{1}{S}$  (high standing-wave ratio) it is more accurate to determine  $\frac{1}{S}$  by a width-of-minimum method rather than by direct measurement.  $\frac{1}{S}$  is related to the voltage at point  $X$ , a distance  $\frac{\Delta X}{2}$  from the minimum by:

$$\frac{1}{S} = \frac{\sin \theta}{\left[ \left( \frac{E_x}{E_{min}} \right)^2 - \cos^2 \theta \right]^{1/2}} \quad (9)$$

where  $\theta = \frac{\pi \Delta X}{\lambda_o}$ .

If  $\Delta X$  is the distance between points where the power is twice that at the minimum (3.01-dB points), then:

$$\frac{1}{S} = \frac{\sin \theta}{(2 - \cos^2 \theta)^{1/2}} \quad (10)$$

For small values of  $\theta$ , ( $< 0.075$  radian),  $\sin \theta = \theta$  and  $\cos \theta = 1$  are close approximations. Then:

$$\frac{1}{S} = \theta = \frac{\pi \Delta X}{\lambda_o}, \quad (11)$$

$$\text{and } \tan \delta = \frac{\Delta X}{d}. \quad (12)$$

If the minimum is very narrow it may be desirable to use points more widely separated, such as the 10-dB points. In that case, for small  $\theta$

$$\frac{1}{S} = \frac{\pi \Delta X}{3\lambda_o}, \quad (13)$$

$$\text{and } \tan \delta = \frac{\Delta X}{3d}. \quad (14)$$

### MEASURING PROCEDURE

- (1) Insert the sample into the reference air line flush with one end and with no spaces between the pieces in the sample.
- (2) Attach the TYPE 900-WNC Short Circuit so that it is in contact with the sample, as shown in Figure 1b.
- (3) Connect the sample holder to the measuring setup (Figure 2), con-

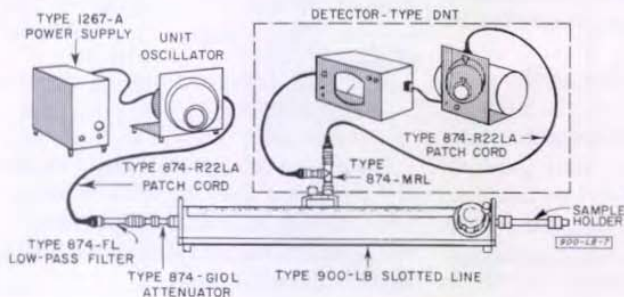

Figure 2. Setup for dielectric measurements.



sisting of the TYPE 900-LB Slotted Line, a TYPE DNT-3 or DNT-4 Heterodyne Detector, and an appropriate generator, such as a GR Unit oscillator. A TYPE 874-G Fixed Attenuator or an isolator should be used between the generator and the slotted line. An amplitude-modulated source and a standing-wave indicator can be used if the frequency modulation of the source is kept very small.

(4) Adjust the frequency so that a voltage minimum occurs at the face of the dielectric sample, whether or not the sample completely fills the length of the holder. To do this, compare the positions of the minima first with the sample holder (containing the sample) on the TYPE 900-LB Slotted Line and then with a TYPE 900-WN Short Circuit on the slotted line. Then adjust the frequency until the proper relation exists between the minima. For example, if the sample completely fills the TYPE 900-LZ Reference Air Line, the minimum position with a TYPE 900-WN or -WNC Short Circuit connected to the slotted line should be the same as when the sample is connected to the slotted line. If measurements must be made at a certain frequency, then it is necessary either to adjust the length of the sample or to use equations (2) and (3) with  $X_0$  not equal to zero.<sup>5</sup>

(5) Once the frequency is properly adjusted, proceed as follows: Record the position and width of the minimum at two places along the slotted line (one of them near the load end), preferably separated by 20 centimeters or more. Measure the width of minimum with the micrometer carriage drive. Count

the number of half wavelengths between the two minima (distance between adjacent minima is  $\lambda_0/2$ ). Then remove the sample from the holder, attach the empty sample holder to the line, and record the position and width of a minimum near the load end of the slotted line.

#### INTERPRETATION OF DATA

With the sample in place, the resulting width of minimum is determined by loss in the dielectric, loss in the sample holder, and loss in the slotted line up to the point of measurement. The width of minimum at a second point along the slotted line is increased by the loss in the slotted line between the two points. The width of minimum, with the sample holder empty, is determined by the losses in the sample holder and in the slotted line to the point of measurement. In order to determine the loss tangent of the dielectric, it is necessary to separate the dielectric loss from the other losses. Call  $\Delta X_{1s}$  the width of minimum at position  $l_{1s}$  with the sample in place,  $\Delta X_{2s}$  the width of minimum at position  $l_{2s}$ , and  $\Delta X_{1e}$  the width of minimum at position  $l_{1e}$ , with the sample holder empty. Then the width of minimum due to loss in the dielectric is given by:

$$\Delta X_d = \Delta X_{1s} - \Delta X_{1e} - \frac{l_{1s} - l_{1e}}{l_{2s} - l_{1s}} \times (\Delta X_{2s} - \Delta X_{1s}). \quad (15)$$

This width of minimum can be used in equation (12) or (14) to determine the loss tangent. The dielectric constant can be found from equation (7). If the approximate dielectric constant is unknown, then measurement at two frequencies will be necessary since  $N_s$  will not be known.

<sup>5</sup> A. von Hippel gives charts of  $\frac{\tanh X}{X}$  and tables of  $\frac{\tan X}{X}$  and suggests further references.

Example: A Teflon\* sample 15.00 centimeters long is measured. It is found that a voltage minimum occurs at the sample face when the frequency is adjusted so that  $\lambda_0 = 21.34$ .

Then from equation (7)  $\epsilon_r = \left(\frac{N_s \lambda_0}{2d}\right)^2 = \left(\frac{N_s 21.34}{2(15.00)}\right)^2$ . The dielectric constant is known to be approximately 2. There-

fore,  $N_s = 2$  and  $\epsilon_r = \left(\frac{2(21.34)}{2(15.00)}\right)^2 = 2.024$ . Since the minimum is very narrow, the 10-dB width-of-minimum points are used. The width of minimum at  $l_{1s} = 21.34$  is 0.1004 cm. The width of minimum at  $l_{2s} = 42.68$  is 0.1518 cm. With the sample holder empty, the width of minimum at  $l_{1e} = 17.01$  is 0.0788 cm. Then the width due to losses in the sample is found from equation (15) as

$$\Delta X_d = 0.1004 - 0.0788 - \frac{(21.34 - 17.01)}{(42.68 - 21.34)} \times (0.1518 - 0.1004) = 0.0110.$$

$$\text{From equation (14), } \tan \delta = \frac{0.0110}{3(15.00)} = 0.00024.$$

Note that if a lossy material is measured ( $\tan \delta > 0.1$ ), equations (2) and (3) are no longer valid and equation (1) must be solved.<sup>4</sup>

#### FREQUENCY RANGE OF MEASUREMENT

The lowest frequency at which measurements can be made is determined by the dielectric constant of the material being measured and by the necessity that at least one minimum occur along

\* DuPont trademark.

<sup>4</sup> *Ibid.*

<sup>5</sup> W. B. Westphal, "Techniques at Measuring the Permittivity and Permeability of Liquids and Solids in the Frequency Range 3 c/s to 50 kMc/s," *Technical Report No. 32, Laboratory for Insulation Research, M.I.T., July 1950.* (Out of print)

the slotted line so that its position and width can be measured. TYPE 900-L10, -L15, and -L30 Precision Air Lines can be used between the sample holder and the slotted line to position a minimum on the slotted line at low frequencies. If these additional air lines are used they should be externally supported. Sample holders up to 66 centimeters long can be constructed for low-frequency use. The sample can be made shorter than a half-wavelength and equations (2), (3), (5), and (6) used to determine the dielectric constant and loss tangent. With these methods, measurements can be made down to 50 MHz or even lower.

The upper frequency limit for the TYPE 900-LB Slotted Line is 8.5 GHz, but special precautions should be taken at frequencies higher than  $\frac{9.5 \text{ GHz}}{\sqrt{\epsilon_r}}$  as noted in the paragraph *Existence of Higher-Order Modes.*

#### ERRORS

##### Sample Fit

One of the most common sources of error in dielectric measurements by the coaxial method is the presence of air gaps between the sample and the inner and outer conductors. Correction formulas based upon a uniform distribution of the air gap can be used, but, since the actual air gap will usually not be uniformly distributed, the gaps should be avoided for maximum accuracy. The corrections for uniform air gaps for  $\tan \delta < 0.1$  are

$$\epsilon_r (\text{correct}) = \epsilon_r (\text{measured}) \frac{L_2}{L_2 - \epsilon_r (\text{measured}) L_1} \quad (16)^6$$

$$\tan \delta (\text{correct}) = \tan \delta (\text{measured}) \left(1 + \epsilon_r (\text{correct}) \frac{L_1}{L_2}\right) \quad (17)^6$$



$$\text{where } L_1 = \text{Log} \frac{D_2}{D_1} + \text{Log} \frac{D_4}{D_3},$$

$$L_2 = \text{Log} \frac{D_3}{D_2},$$

$$L_3 = \text{Log} \frac{D_4}{D_1},$$

$$D_1 = 0.24425,$$

$D_2 =$  inside diameter of sample,

$D_3 =$  outside diameter of sample,  
and

$$D_4 = 0.5625.$$

#### Meter Errors

If a 3-dB width of minimum is used, meter indications on the GR TYPE 1216-A Unit I-F Amplifier will, in general, cause negligible error when the upper part of the scale is used and when care is taken to tune the local-oscillator frequency exactly for maximum output. A 10-dB width-of-minimum measurement may require that the i-f amplifier calibration be checked with a precision attenuator for greatest accuracy. As an example of the errors in loss-tangent measurements caused by poor i-f amplifier calibration, an error of 0.1 dB in a typical 3-dB width-of-minimum measurement will cause an error of 1.9% in  $\tan \delta$ . An error of 0.3 dB in a typical 10-dB width-of-minimum measurement will result in a 3.9% error in  $\tan \delta$ .

#### Effect of Contact Resistance

Although the connector contact resistance is typically less than half a milliohm, a small part of the measured loss is due to this resistance. The magnitude of the error caused by this loss depends upon the relative current through the contact for each measurement and is significant only when very low-loss dielectrics are measured. If the

current is the same when the sample is measured as when the empty sample holder is measured, the contact loss will have no effect on the accuracy of the  $\tan \delta$  measurement. If the currents differ, there may be an error in  $\tan \delta$  as large as 0.0001. The amount of loss due to the finite contact resistance in a given measurement is

$$\text{Loss} = \frac{\cos 2\theta + 1}{2} \times \text{maximum loss}, \quad (18)$$

where  $\theta = \frac{l}{\lambda} 360^\circ$  and  $l$  is the distance

from a voltage minimum to the contact. Maximum loss occurs when a voltage minimum occurs at the contact. It is difficult to evaluate the maximum loss exactly because of its small value. The condition that the current be the same for both measurements (with and without sample) may be met by appropriate choice of length and frequency for a sample with a given dielectric constant. If the dielectric constant is unknown, it may be necessary first to measure dielectric constant and then to trim the sample to the proper length for accurate determination of loss. This is necessary only for very accurate measurements of the loss tangent of low-loss dielectrics. For low-loss materials, the current through the contacts will be of approximately the same magnitude with and without the sample in the holder when the frequency and length are so chosen that sample

$$\text{length } d = \frac{2 N_s b}{(N + 1) \sqrt{\epsilon + N_s}}, \quad (19)$$

$$\text{and } \lambda_0 = \frac{2 \sqrt{\epsilon}}{N_s} d, \quad (20)$$

where  $N_s$  and  $N$  are integers and  $b$  is the length of the sample holder. Lengths



John F. Gilmore received his BSEE degree in 1961 and his MSEE in 1963, from Northeastern University. He was employed as a co-operative student at Alford Manufacturing Company and as an engineer with that company from 1961 to 1963. He joined the Microwave Group at General Radio as a development engineer in 1963 and is currently engaged in microwave circuit design.



6, 7. If, instead, a sample 13.54 cm long were chosen,  $\tan \delta$  could be measured with maximum accuracy only at  $\lambda_0 = 5.48$  cm,  $N_s = 7$ .

**Existence of Higher-Order Modes**

At frequencies higher than  $\frac{9.5}{\sqrt{\epsilon}}$  GHz,

higher-order modes, particularly the  $TE_{11}$  mode, can be excited by axial dissymmetries in the dielectric material. While the air-filled section of line between the sample and the point of measurement acts as a filter for these higher-order modes, in some instances coupling between the TEM and TE modes may be great enough to produce an error in measurement. Measurements above this frequency, therefore, should be made at small (say 10%) frequency increments and compared with measurements below  $\frac{9.5}{\sqrt{\epsilon}}$  GHz, in order that anomalous results can be detected.

— J. F. GILMORE

that satisfy the relationship and the corresponding values of  $N_s$  can be determined from Figure 3 for a 15-cm sample holder and from Figure 4 for a 30-cm sample holder. Figure 4 shows only the most useful curve of a very large family of curves. As an example of the use of these curves, suppose that the loss tangent of a low-loss material with a dielectric constant of 2 is to be measured. If a sample 12.43 cm long is used in a 15-cm sample holder,  $\tan \delta$  can be measured with maximum accuracy at  $\lambda_0 = 17.60$  cm, 11.73 cm, 8.80 cm, 7.05 cm, 5.87 cm, and 5.03 cm, corresponding to  $N_s = 2, 3, 4, 5,$

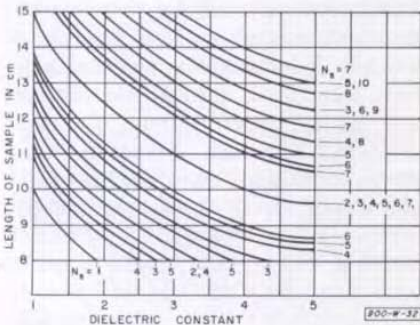

Figure 3. Lengths of samples for a Type 900-LZ15 Reference Air Line for minimum  $\tan \delta$  error in low-loss dielectric measurements. (See equations 18 and 19.)

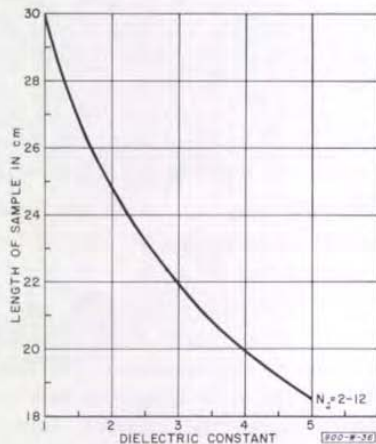

Figure 4. Lengths of samples for a Type 900-LZ30 Reference Air Line for minimum  $\tan \delta$  error in low-loss dielectric measurements.

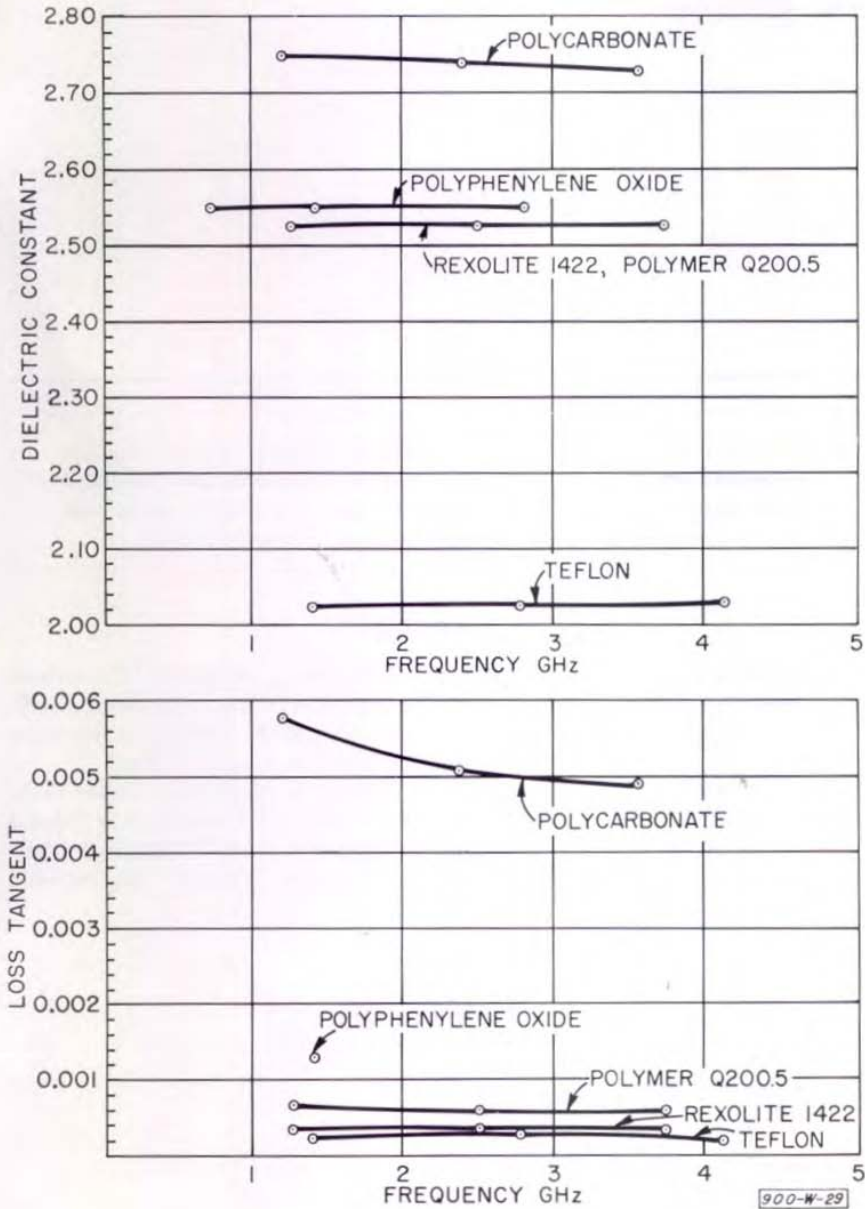

Figure 5. Dielectric constant and loss tangent of typical materials as measured on the Type 900-LB Precision Slotted Line.

**GENERAL RADIO COMPANY**  
WEST CONCORD, MASSACHUSETTS 01781

DO WE HAVE YOUR CORRECT NAME AND ADDRESS—name, company or organization, department, street or P.O. box, city, state, and zip code? If not, please clip the address label on this issue and return it to us with corrections, or if you prefer, write us; a postcard will do.

## PAPERS

General Radio engineers will present three papers at the 1966 Conference on Precision Electromagnetic Measurements to be held at the National Bureau of Standards, Boulder, Colorado, June 21-24:

Robert A. Soderman, "Application of Precision Connectors to High-Frequency Measurements."

John Zorzy, "Skin-Effect Corrections in Immittance and Scattering-Coefficient Standards Employing Precision Air-Dielectric Coaxial Lines."

Thomas E. MacKenzie, "Some Techniques and their Limitations as Related to the Measurement of Small Reflections in Precision Coaxial Transmission Lines."

---

**GENERAL RADIO COMPANY**

WEST CONCORD, MASSACHUSETTS 01781