

1910

Inductance Analyzer User and Service Manual



Copyright © 2017 IET Labs, Inc.
Visit www.ietlabs.com for manual revision updates

1910 im/Oct 2017

◆ PRECISION INSTRUMENTS FOR TEST AND MEASUREMENT ◆

WARRANTY

We warrant that this product is free from defects in material and workmanship and, when properly used, will perform in accordance with applicable IET specifications. If within one year after original shipment, it is found not to meet this standard, it will be repaired or, at the option of IET, replaced at no charge when returned to IET. Changes in this product not approved by IET or application of voltages or currents greater than those allowed by the specifications shall void this warranty. IET shall not be liable for any indirect, special, or consequential damages, even if notice has been given to the possibility of such damages.

THIS WARRANTY IS IN LIEU OF ALL OTHER WARRANTIES, EXPRESSED OR IMPLIED, INCLUDING BUT NOT LIMITED TO, ANY IMPLIED WARRANTY OF MERCHANTABILITY OR FITNESS FOR ANY PARTICULAR PURPOSE.



WARNING



OBSERVE ALL SAFETY RULES
WHEN WORKING WITH HIGH VOLTAGES OR LINE VOLTAGES.

**Dangerous voltages may be present inside this instrument. Do not open the case
Refer servicing to qualified personnel**

HIGH VOLTAGES MAY BE PRESENT AT THE TERMINALS OF THIS INSTRUMENT

WHENEVER HAZARDOUS VOLTAGES (> 45 V) ARE USED, TAKE ALL MEASURES TO
AVOID ACCIDENTAL CONTACT WITH ANY LIVE COMPONENTS.

USE MAXIMUM INSULATION AND MINIMIZE THE USE OF BARE
CONDUCTORS WHEN USING THIS INSTRUMENT.

Use extreme caution when working with bare conductors or bus bars.

WHEN WORKING WITH HIGH VOLTAGES, POST WARNING SIGNS AND
KEEP UNREQUIRED PERSONNEL SAFELY AWAY.



CAUTION



DO NOT APPLY ANY VOLTAGES OR CURRENTS TO THE TERMINALS OF THIS
INSTRUMENT IN EXCESS OF THE MAXIMUM LIMITS INDICATED ON
THE FRONT PANEL OR THE OPERATING GUIDE LABEL.

Contents

Warranty	7
Specifications	9
Accessories	11
Safety Precautions	15
Condensed Operating Instructions	17
Installation and Power Up	17
Selecting Test Conditions	18
Zeroing	24
Connection to Device Under Test	30
Initiating Tests	30
Introduction - Section 1	
1.1 Unpacking/Inspection	33
1.2 Product Overview	33
1.3 Front Panel Description	34
1.4 Rear Panel Description	35
1.5 Installation	36
1.5.1 Dimensions	36
1.5.2 Instrument Positioning	36
1.5.3 Power Requirements	36
1.5.4 Safety Inspection	38
Operation - Section 2	
2.1 Terms and Conventions	39
2.2 Power Up	41
2.3 Program/Setup Procedure (Test 1–25)	41
2.3.1 Primary Parameter	42
2.3.2 Secondary Parameter	45
2.3.3 Frequency	46
2.3.4 Amplitude	46
2.3.5 Bias Current	47
2.3.6 Range Select	48
2.3.7 Accuracy	50
2.3.8 Delay	53
2.3.9 No. to Average	54
2.3.10 Primary Nominal	55
2.3.11 Bin Type	56
2.3.12 Secondary Nominal	59

Contents (continued)

2.3.13	Load Correction	60
2.3.14	Primary Load Correction	61
2.3.15	Secondary Load Correction	61
2.4	Program/Sequence (Test S1-S9)	62
2.5	Utility Functions	64
2.5.1	Perform Calibration	65
2.5.2	Keypad Lockout.....	69
2.5.3	Display Type.....	72
2.5.4	Numeric Format	73
2.5.5	Trigger Source	74
2.5.6	Source Impedance.....	74
2.5.7	RS-232 Baud Rate.....	75
2.5.8	IEEE488 Address	75
2.5.9	Clear All Tests	76
2.5.10	Leveling	76
2.5.11	Cable Comp.	77
2.5.12	Frequency Edit Type.....	77
2.5.13	Median	78
2.5.14	Distortion	78
2.5.15	Serial Number	79
2.5.16	Software Version	79
2.6	Error Messages	79
Interface - Section 3		
3.1	General.....	81
3.2	Remote I/O.....	81
3.3	RS-232 Interface	83
3.4	IEEE-488.2 Interface	84
3.4.1	General.....	84
3.4.2	IEEE-488 Connections	85
3.4.3	IEEE-488 & RS-232 Commands	86
3.4.4	Remote Calibration	92
3.4.5	Formats	96

Contents (continued)

Theory - Section 4

4.1	Introduction.....	99
4.1.1	Description of 1910 Inductance Analyzer	99
4.1.2	Block Diagram	101
4.2	Principle Functions	103
4.2.1	Fundamental Measurement.....	103
4.2.2	Sine Wave and Sampling Pulse Generator	104
4.2.3	Digitization	104

Maintenance - Section 5

5.1	General.....	107
5.2	Instrument Return	107
5.3	Calibration	107
5.3.1	1910 Verification Procedure	107
5.3.2	1910 Verification Data Sheet	110
5.4	Diagnostics.....	112
5.4.1	Start-up Diagnostics.....	112

Warranty

IET Labs. warrants that Products are free from defects in material and workmanship and, when properly used, will perform in accordance with IET Labs.'s applicable published specifications. If within one (1) year after original shipment it is found not to meet this standard, it will be repaired, or at the option of IET Labs., replaced at no charge when returned to a IET Labs. service facility.

Changes in the Product not approved by IET Labs. shall void this warranty.

IET Labs. shall not be liable for any indirect, special or consequential damages, even if notice has been given of the possibility of such damages.

This warranty is in lieu of all other warranties, expressed or implied, including, but not limited to any implied warranty or merchantability or fitness for a particular purpose.

SERVICE POLICY

IET Labs. policy is to maintain product repair capability for a period of at least five (5) years after original shipment and to make this capability available at the then prevailing schedule of charges.

Specifications

Measure Parameters:

Parameter	Range	Basic Accuracy		
		Low	Medium	High
Ls, Lp	0.001nH to 99.999H	±0.5%	±0.25%	±0.1%
Cs, Cp	0.01pF to 9.9999F	±0.5%	±0.25%	±0.1%
D	.00001 to 99.999	±0.005	±0.0025	±0.001
Q	.00000 to 9999.9	±0.005	±0.0025	±0.001
Y, Gp, Bp	10nS to 9999.9S	±0.005	±0.0025	±0.001
Z , Rs, Rp, Xs, ESR	0.00001mΩ to 99.999MΩ	±0.5%	±0.25%	±0.1%
Phase Angle	-180.00 to +179.99°	±1.8°	±0.9°	±0.18°
DCR	0.1000mΩ to 100.00kΩ	±0.5%	±0.25%	±0.2%
DUT AC Voltage	20mV to 1.000V	±(2% +5mV) @ 1kHz		
DUT AC Current	1.000μA to 150.00mA	±(2% +5μA) @ 1kHz		
DUT DC Voltage	20mV to 1.000V	±(2% +5mV)		
DUT DC Current	1μA to 150mA	±(2% +5μA)		

Test Frequency: Range: 20Hz to 1MHz
Resolution: 1.0Hz from 20Hz to 1kHz; 4 digits > 1kHz
Accuracy: ±(0.02% + 0.02Hz)

	<u>Speed</u>	<u>Accuracy Setting</u>
Measurement Speed:	40 meas/sec	Low, No Display
	25 meas/sec	Low
	10 meas/sec	Medium
	1 meas/sec	High
	May be longer, depending on test conditions & frequency	
	DC measurements take 2x as long as AC measurements	

Ranging: Automatic, Range Hold or Locked

Trigger: Internal (automatic)
External (via RS-232, IEEE-488 or Handler interfaces)
Manual

Source Impedance: 5Ω, 25Ω, 50Ω, or 100Ω

AC Test Signal: 20mV to 1.0V (open circuit) in 5mV steps

DC Test Signal: 20mV to 1.0V (open circuit) in 5mV steps, 5Ω source impedance

Specifications (Continued)

Bias Current:	Internal: 1mA to 1A in 1mA steps External: 0 to 20A in 5mA steps (using IET Labs. 1320)
Display:	LCD display with backlight
Results Format:	Engineering Numeric Deviation from Nominal of Primary Parameter % Deviation from Nominal of Primary Parameter No Display (for maximum throughput)
Interfaces:	IEEE-488, RS-232, Handler I/O
Measurement Delay:	0 to 100s, programmable in 10 ms steps
Averaging:	1 to 1000, programmable
Mechanical:	Bench Mount (optional rack mount flanges available, 2000-16)
Dimensions:	(w x h x d):432x133x406mm
Weight:	8kg net, 9.9kg shipping
Environmental:	MIL-T28800E, Type 3, Class 5, Style E & F Operating: 0 to +50°C Storage: -40 to +71°C Humidity: <75 for <+40°C operating Altitude: <2000m, Installation Category 1 Pollution Degree 1
Power:	100 to 240VAC 50 – 60Hz 100W max

Accessories

Accessories Included

Item	Quantity	IET Labs. P/N
AC Power Cord	1	4200-0300
Power Line Fuse (installed in instrument)	1	520049
Instruction Manual	1	150491
Calibration Certificate	1	N/A

Accessories/Options Available

Item	Quantity	IET Labs. P/N
Axial/Radial Component Test Fixture	1	1689-9600
4 BNC Connectors to 2 Kelvin Clip Lead Set	1	1700-03
4 BNC Connectors to 4 Banana Plugs	1	1700-04
4 BNC Connectors to 2 Chip Component Tweezers	1	7000-05
4 BNC to 4 BNC Cable Set (1 meter)	1	1689-9602
4 BNC to 4 BNC Cable Set (2 meters)	1	1689-9602-2
Low Voltage Chip Component Test Fixture	1	7000-07
Rack Mount Flanges	1	2000-16

Accessories (Continued)



Figure A-2: 1689-9600 Axial/Radial Remote Test Fixture

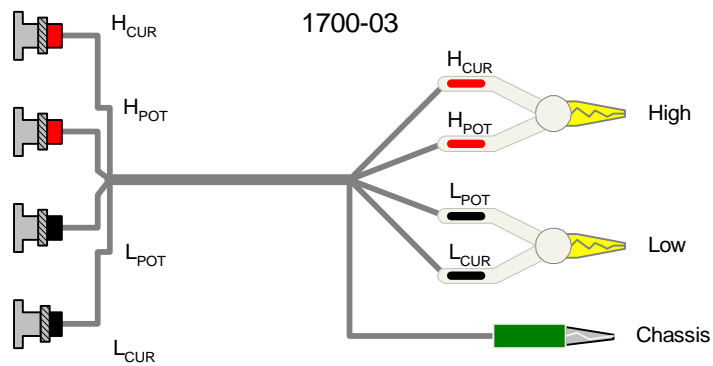

Figure A-3: 1700-03 BNC (4) Connectors to 2 Kelvin Clip Lead Set

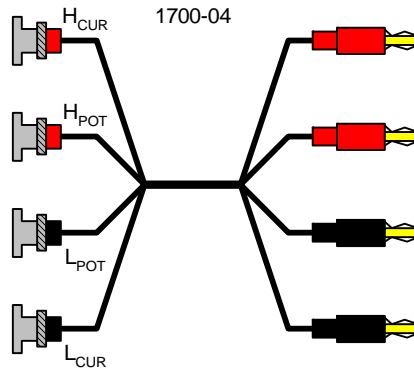

Figure A-4: 1700-04 BNC (4) Connectors to Banana Plugs (4)

Accessories (Continued)



Figure A-6:
1689-9602 BNC (4) to BNC (4) Cable Set, 1 meter
1689-9602-2 BNC (4) to BNC (4) Cable Set, 2 meters

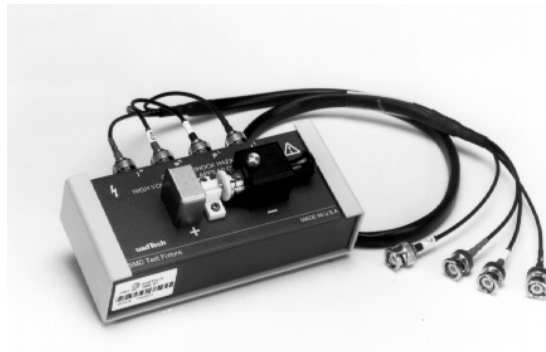

Figure A-7: 7000-07 Low Voltage Chip Component Test Fixture

Accessories (Continued)

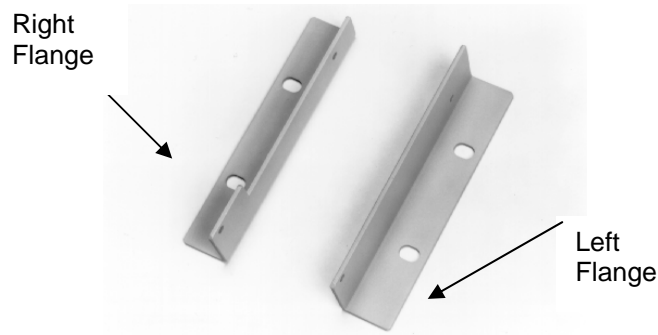

Figure A-8: 2000-16 Rack Mount Flanges

The 2000-16 Rack Mount Flanges (quantity 2, left and right) are used as dress panels to adapt the 1910 to the standard 482.6 mm (19 inch) rack width. **THESE FLANGES SHOULD NOT BE USED AS SOLE MOUNTING SUPPORT OF THE 1910** in rack mount applications. Chassis guides or other mechanical support is required to support the instrument. Chassis guides are available from:

Amco Engineering Company
3801 North Rose Street
Schiller Park, Illinois 60176-2190
Telephone (847) 671-6670

Installation

WARNING

MAKE SURE THE UNIT HAS BEEN DISCONNECTED FROM ITS AC POWER SOURCE FOR SEVERAL MINUTES BEFORE PROCEEDING.

- 1) Remove the 4 screws and washers, two each side on the front side cover.
- 2) Mount the two flanges using the screws and washers previously removed. Note that the flange with the cutout is to be mounted on the right so as not to cover the side vent holes. Refer to the figure below.

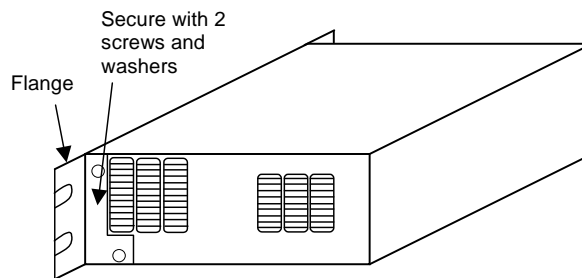

Figure A-9: Flange Mounting

Safety Precautions

The 1910 Inductance Analyzer can provide an output voltage to 1.0V AC and current to 1A DC to the device under test (DUT). Although the 1910 unit is designed with full attention to operator safety, serious hazards could occur if the instrument is used improperly and these safety instructions are not followed.

1. The 1910 Inductance Analyzer unit is designed to be operated with its chassis connected to earth ground. The instrument is shipped with a three-prong power cord to provide this connection to ground. This power cord should only be plugged in to a receptacle that provides earth ground. Serious injury can result if the 1910 Inductance Analyzer is not connected to earth ground.
2. Tightly connect the 4 BNC test cables or test fixture to the front panel connectors. If this is not done improper measurements are possible, or an electrical shock to the operator could result if the DUT is touched.
3. Never touch the test leads, test fixture or DUT in any manner (this includes insulation on all wires and clips) when the bias current is applied and the **BIAS ON** light is on.
4. Before turning on the 1910 Inductance Analyzer unit, make sure there is no device (DUT) or fixture connected to the test leads.
5. Before touching the test leads or device under test make sure:
 - a) Any capacitive device has had enough discharge time.
 - b) The green **BIAS ON LED** is NOT lit.
6. **In the case of an emergency**, turn OFF the POWER switch using a “hot stick” and disconnect the AC power cord from the wall. **DO NOT TOUCH THE 1910 INSTRUMENT.**
Position the equipment so it is easy to disconnect. Disconnect by means of the power plug or power connector.
7. When the 1910 Inductance Analyzer instrument is used in remote control mode, be extremely careful. Output voltage or current can be turned on and off with an external signal.

Safety Symbols

The product is marked with the following safety symbols.



Product will be marked with this symbol (ISO#3864) when it is necessary for the user to refer to the instruction manual in order to prevent injury or equipment damage.



Product marked with this symbol (IEC417) indicates presence of direct current.



Product will be marked with this symbol (ISO#3864) when voltages in excess of 1000V are present.

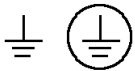

Indicates the grounding protect terminal, which is used to prevent electric shock from the leakage on chassis. The ground terminal must connect to earth before using the product.

Warning Procedure can cause hazard to human if the warning is neglected.

Caution Avoid product misuse. It may cause damage to the product itself and the DUT if the caution is neglected.

Note Important information or tips for the procedures and applications.

Warning Signal During Testing

“DANGER – HIGH VOLTAGE TEST IN PROGRESS, UNAUTHORIZED PERSONS KEEP AWAY”

Disposal

Do not dispose of electrical appliances as unsorted municipal separate collection facilities. Contact your local government for information regarding the collection systems available. If electrical appliances are disposed of in landfills or dumps, hazardous substances can leak into the groundwater and get into the food chain, damaging your health and well-being. When replacing old appliances with new one, the retailer is legally obligated to take back your old appliances for disposal.

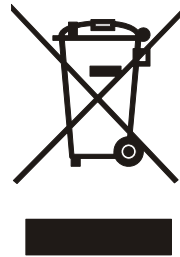

waste, use

Condensed Operating Instructions

Start-Up

The 1910 Inductance Analyzer can be operated from a power source between 90 and 250 VAC at a power line frequency of 50 to 60 Hz. The unit is shipped with a 2.5A fuse in place for 90 to 250 V operation. Refer to paragraph 1.5.3 for fuse location and/or replacement.

The 1910 Inductance Analyzer is designed to be operated with its chassis connected to earth ground, a 3-prong power cord is provided with the unit to make this connection. Connect one end of the power cord to the instrument's rear panel power receptacle and the other end to the proper ac power source.

Press the Power button on the front panel to the (1) position to apply power. The power can be switched off at any time by pressing the this front panel switch to the (0) position.

Power Up

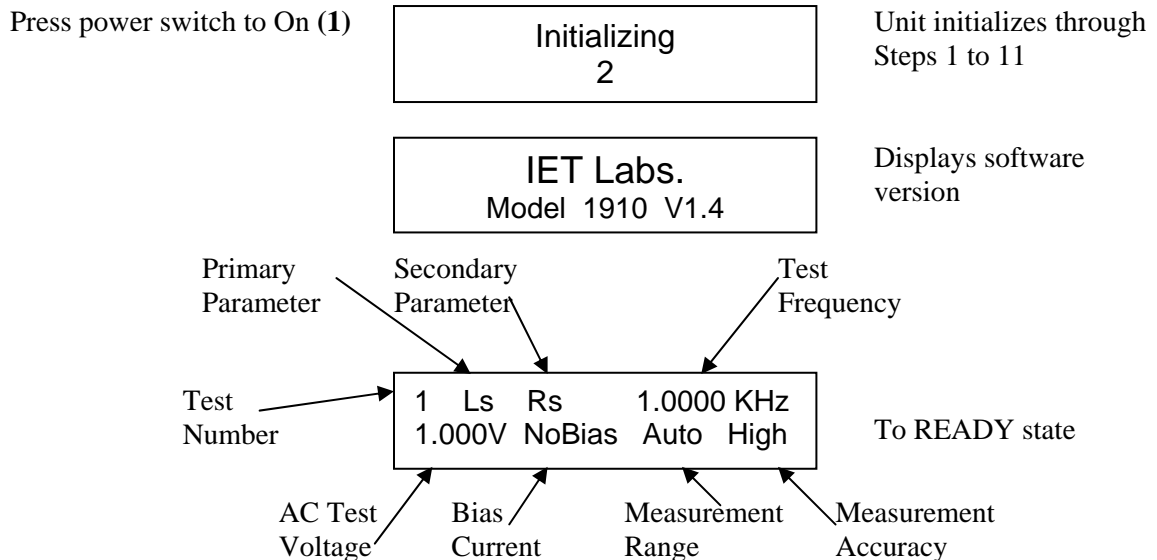

Programming Test Conditions

Programming Test Conditions

Press the **UP** or **DOWN** arrow to select **test #** (location where test conditions are stored).

UP ▲

1	Ls	Rs	1.000kHz
	1.000V	No Bias	Auto High

Test # (1 - 30)

Sequence Test # (S1 - S10)

Refer to paragraph 2.4

Press **PROGRAM** to enter programming mode

[PROGRAM]

1	Prim Param	Program
	Automatic	

Press [PROGRAM] at any time to exit programming mode.

Measured Parameters

Press the **UP** or **DOWN** arrow to select **measurement** parameter

UP ▲

1	Prim Param	Program
	Ls	

Automatic, Ls, Lp, Rs, Rp, Cs, Cp, DF, Q, Z, Y, P, ESR, Gp, Xs, Bp, V, I, DCV, DCR, DCI

Press the **RIGHT** arrow to select **secondary measurement** parameter

Right ►

1	Sec Param	Program
	No Secondary param	

Not shown if Primary Parameter is set to Automatic

Press the **UP** or **DOWN** arrow to enter **secondary measurement** parameter

UP ▲

1	Sec Param	Program
	Q	

Ls, Lp, Rs, Rp, Cs, Cp, DF, Q, Z, Y, P, ESR, Gp, Xs, Bp, V, I, No secondary parameter

Frequency

Press the **RIGHT** arrow to select **test frequency**

Right ►

1	Frequency	Program
	20.000 Hz	

Not shown if Primary Parameter is set to DCV, DCR or DCI

Press the **UP** or **DOWN** arrow to enter **test frequency** parameter

UP ▲

1	Frequency	Program
	1.0000 kHz	

20 Hz - 1.0 MHz, 15 steps or 20 Hz - 1.0 MHz, continuous Refer to paragraph 2.3.3

Programming - continued:

Amplitude

Press the **RIGHT** arrow to select **amplitude** of voltage

Right ►

1	Amplitude	Program
	20.00 mV	

Press the **UP** or **DOWN** arrow to change **amplitude** value

UP ▲

1	Amplitude	Program
	1.0000 V	

 20.00mV - 1.0000V
in 5mV steps

Bias Current

Press the **RIGHT** arrow to select **bias current**

Right ►

1	Bias Current	Program
	1.00 mA	

 Not shown if Primary
Parameter is set to DC

Press the **UP** or **DOWN** arrow to change **bias current** value

UP ▲

1	Bias Current	Program
	Off	

 Off, 1.00mA - 1.000A
in 1mA steps

Measure Range

Press the **RIGHT** arrow to select **measurement range**

Right ►

1	Range Select	Program
	Lock 200mA, any F	1.0V

Press the **UP** or **DOWN** arrow to change **measurement range** value

UP ▲

1	Range Select	Program
	Lock 200mA, any F, 1.0V	

 Auto, Hold or 27 individual
ranges (45 for DC), refer
to paragraph 2.3.6

Accuracy

Press the **RIGHT** arrow to select **measurement accuracy**

Right ►

1	Accuracy	Program
	Low (40ms test)	

Press the **UP** or **DOWN** arrow to change **measurement accuracy** value

UP ▲

1	Accuracy	Program
	High (1 second test)	

 High, Medium, Low or
No Display

Programming - continued:

Delay

Press the **RIGHT** arrow to select **delay time**

Right ►

1	Delay	Program
	0.00 ms	

Press the **UP** or **DOWN** arrow to change **delay time** value

UP ▲

1	Delay	Program
	100.00 sec	

 Off, or 100msec to 100.00sec
in 10msec steps

Averaging

Press the **RIGHT** arrow to select **number to average**

Right ►

1	No. to avg	Program
	99	

Press the **UP** or **DOWN** arrow to change **number to average** value

UP ▲

1	No. to avg	Program
	1	

 1 to 1000 in increments of 1

Primary Nominal

Press the **RIGHT** arrow to select **primary nominal**

Right ►

Pri Nominal	(START = get)
1.0000 H	

 Not shown if Primary
parameter is set to Automatic

Press the **UP** or **DOWN** arrow to change **primary nominal** value

UP ▲

Pri Nominal	(START = get)
900.000 mH	

 Range of values and units
depend on primary parameter
selected at first step

Programming – continued:

Binning (Primary Parameter)

Press the **RIGHT** arrow to select **bin** type

Right ►

1 Bin Type Program
Off

Not shown if Primary
Parameter is set to Automatic

Press the **UP** or **DOWN** arrow to change **bin** type

UP ▲

1 Bin Type Program
Absolute

Absolute, Percent Deviation
or Off

Press the **RIGHT** arrow to select **binning HIGH limit** value

Right ►

1 Bin 1 HiLim Program
100.00 mH

Not shown if Binning is set to
Off for all bins

Press the **UP** or **DOWN** arrow to change **binning HIGH limit** value

UP ▲

1 Bin 1 HiLim Program
110.0 mH

Off, or limit in value and units
for Absolute Limit, or value in %
for % deviation (-100%+200%)

Press the **RIGHT** arrow to select **binning LOW limit** value

Right ►

1 Bin 1 LoLim Program
100.00 mH

Press the **RIGHT** arrow to change **binning LOW limit** value

UP ▲

1 Bin 1 LoLim Program
90.00 mH

Off, or limit in value and units
for Absolute Limit, or value in %
for % deviation (-100%+200%)

Bins 2 through 10

Limits can be set to Off at the point
where Hi and Lo values converge

Press the **RIGHT** arrow to select **Hi and Lo limits for Bins 2 - 10**

Right ►

1 Bin 10 LoLim Program
100.00 mH

Press the **UP** or **DOWN** arrow to change **Hi and Lo limits for Bins 2-10**

UP ▲

1 Bin 10 LoLim Program
50.00 mH

Off, or limit in value and units
for Absolute Limit, or value in %
for % deviation (-100%+200%)

Programming – continued:

Secondary Nominal

Press the **RIGHT** arrow to select **secondary nominal** value

Right ►

1	Sec Nominal	Program
	Off	

Not shown if Primary Parameter is set to Automatic

Press the **UP** or **DOWN** arrow to change **secondary nominal** value

UP ▲

1	Sec Nominal	Program
	10.000	

Off, or range of values and units that depend on secondary parameter

Binning (Secondary Parameter)

Press the **RIGHT** arrow to select **secondary HIGH limit** value

Right ►

1	Sec HiDev	Program
	1.0000	

Not shown if Primary Parameter is set to Auto or Binning is set to Off for all bins

Press the **UP** or **DOWN** arrow to change **secondary HIGH limit** value

UP ▲

1	Sec HiDev	Program
	12.000	

Off, or range of value and units dependent on the secondary parameter

Press the **RIGHT** arrow to select **secondary LOW limit** value

Right ►

1	Sec LoLim	Program
	1.0000	

Press the **RIGHT** arrow to change **secondary LOW limit** value

UP ▲

1	Bin 1 LoLim	Program
	8.0000	

Off, or range of value and units dependent on the secondary parameter

Programming – continued:

Load Correction

Press the **RIGHT** arrow to select **load correction**

Right ►

LoadCorrect (START = GET) Off

 Not shown if Primary parameter is set to Automatic

Press the **UP** or **DOWN** arrow to change **load correction** value

UP ▲

LoadCorrect (START = GET) Measure

 Off, On

Press **[START]** to measure Load Correction based on primary and secondary nominals with device connected **OR**

Press the **RIGHT** arrow to select **primary load correction**

Right ►

1 Pri Load Corr Program 8.0000 mH

Press the **UP** or **DOWN** arrow to change **primary load correction** value

UP ▲

1 Pri LoadCorr Program 1.0000 mH

 range of values and units that depend on primary parameter

Press the **RIGHT** arrow to select **secondary load correction**

Right ►

1 Sec LoadCorr Program 50.000

Press the **UP** or **DOWN** arrow to change **secondary load correction** value

UP ▲

1 Sec LoadCorr Program 1.100

 Range of values and units depend on primary parameter selected at first step

Press the **RIGHT** arrow to return display to **Ready Mode**

Right ►

1 Ls Rs 1.0000 kHz 1.0000V No Bias Auto High

 Ready Mode showing first parameter

Programming Tester Utility Functions

Tester functions are accessed through the UTILITY mode.

[UTILITY] Cal with 1M Cable
Cal Due: 1/10/2001 Press [UTILITY] at any time to exit programming mode.

Perform Calibration/Zeroing

Press the **RIGHT** arrow to skip Open/Short and go to Keypad Lockout with indicated cable length

Right  Cal with 1M Cable
Cal Due: 1/10/2001 Indicates due date of next annual calibration

Press the **UP** or **DOWN** arrow to select **Open/Short Calibration** type

UP  1 Prim Param Program
Ls Quick Short Cal, Quick Open Cal, Quick Short/Open Cal, Short Cal, Open Cal, Short/Open Full Cal

NOTE: "Quick Cal is not an option if test is a sequence test (S1-S9).

NOTE: "Open Cal" and "Quick Open Cal" are not an option if test is a DC test (DCR, DCV, DCI)

To connect Test Leads refer to "Connection to Device Under Test" paragraph that follows.

Right  Connect OPEN standard
Press START to continue Press [STOP] at any time to exit Cal routine

Connect Test Leads in OPEN configuration

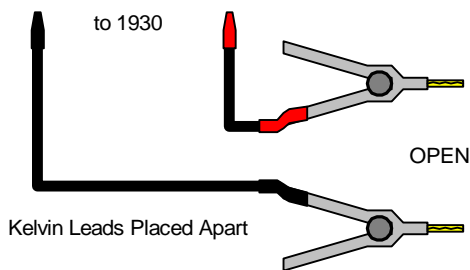

Press the **[START]** to initiate **open calibration** measurement

[START] C: 1 9: F1 I5 V2
Open correction Open Correction factor

Tester Utility Functions – continued

Connect SHORT standard.
Press START to continue.

Remove Open.

Connect Test Leads in SHORT configuration

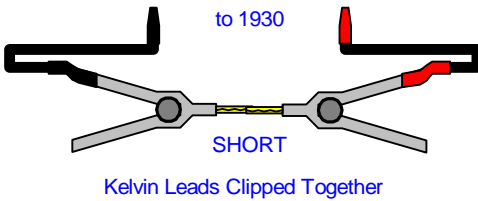

Press the **[START]** to initiate **short calibration** measurement

[START]

C: 1 9: F1 I5 V2
Short correction

Short Correction factor

Calibration Complete
Press START to continue

[START]

1 Ls Rs 1.0000 kHz
1.000V No Bias Auto High

Ready Mode

OR

[UTILITY]

Cal with 1M Cable
Cal Due: 1/10/2001

To program other Tester
Utility Functions

Press the **RIGHT** arrow to program other **UTILITY** functions

Keypad Lockout

Press the **UP** or **DOWN** arrow to change **keypad lockout** type

UP ▲

Keypad Lockout Util
Lock Password

Off, Lock Password or Lock
Cycle Tests Password

Press the **RIGHT** arrow to select **lockout value**

Right ►

Keypad Lockout Util
000000

Press the **UP** or **DOWN** arrow to change **lockout** value

UP ▲

Keypad Lockout Util
888888

0 through 9 for all six digits
Use Right Arrow to select
(move to) next digit

Tester Utility Functions – continued:

Display Type

After last lockout digit, Press the **RIGHT** arrow to select [display type](#)

Right ►

Display Type	Util
Measured Parameters	

Press the **UP** or **DOWN** arrow to change [display type](#)

UP ▲

Display Type	Util
Dev. from nominal	

 Measured Parameters, Dev from Nominal, % Dev from Nominal

Numeric Format

Press the **RIGHT** arrow to select [numeric format](#)

Right ►

Numeric Format	Util
Engineering	

Press the **UP** or **DOWN** arrow to change [numeric format](#) type

UP ▲

Numeric Format	Util
Scientific	

 Engineering or Scientific

Trigger Source

Press the **RIGHT** arrow to select [trigger source](#)

Right ►

Trigger Source	Util
Internal	

Press the **UP** or **DOWN** arrow to change [trigger source](#) type

UP ▲

Trigger Source	Util
External	

 Internal or External

Tester Utility Functions - continued

Source Impedance

Press the **RIGHT** arrow to select [source impedance](#)

Right ►

Source impedance	Util
5Ω	

Press the **UP** or **DOWN** arrow to change [source impedance](#)

UP ▲

Source Impedance	Util
100Ω	

 5Ω, 25Ω, 50Ω or 100Ω

RS-232 Baud Rate

Press the **RIGHT** arrow to select [RS-232 baud rate](#)

Right ►

RS232 Baud Rate	Util
9600	

Press the **UP** or **DOWN** arrow to change [RS-232 baud rate](#) value

UP ▲

RS232 Baud Rate	Util
19200	

 9600, 19200, 9600Auto, 19200Auto, or Disabled

IEEE-488 Address

Press the **RIGHT** arrow to select [IEEE-488 address](#)

Right ►

IEEE-488 Address	Util
1	

 Shown only if RS-232 Baud Rate is Disabled

Press the **UP** or **DOWN** arrow to change [IEEE-488 address](#) value

UP ▲

IEEE-488 Address	Util
16	

 1 through 16

Tester Utility Functions - continued

Clear All Tests

Press the **RIGHT** arrow to select [clear all tests](#)

Right ►

Clear All Tests	Util
No	

Press the **UP** or **DOWN** arrow to change [clear all tests](#)

UP ▲

Clear All Tests	Util
Yes	

 No or Yes

NOTE: If YES is selected, press Right arrow, Up arrow and Right arrow again to clear all tests.

Leveling

Press the **RIGHT** arrow to select [leveling](#)

Right ►

Leveling	Util
Off	

Press the **UP** or **DOWN** arrow to change [leveling](#) value

UP ▲

Leveling	Util
On	

 Off or On

Cable Compensation

Press the **RIGHT** arrow to select [cable compensation](#)

Right ►

Cable Comp.	Util
Front Panel Connect	

Press the **UP** or **DOWN** arrow to change [cable compensation](#) type

UP ▲

Cable Comp.	Util
1M Cable	

 1M, 2M or No Cable

Tester Utility Functions – continued

Frequency Edit Type

Press the **RIGHT** arrow to select [frequency edit type](#)

Right ►

Freq. Edit Type	Util
Discrete	

Press the **UP** or **DOWN** arrow to change [frequency edit type](#)

UP ▲

Freq. Edit Type	Util
Continuous	

 Continuous or Discrete
Refer to paragraph 2.5.12

Median

Press the **RIGHT** arrow to select [median](#)

Right ►

Median	Util
Single Meas.	

Press the **UP** or **DOWN** arrow to change [median](#) type

UP ▲

Median	Util
Median of 3	

 Single Measurement or
Median of 3 measurements

Distortion

Press the **RIGHT** arrow to select [distortion](#)

Right ►

Distortion	Util
Not Tested	

Press the **UP** or **DOWN** arrow to change [distortion](#) type

UP ▲

Distortion	Util
Checked during AC test	

 Not Tested or Checked during
AC Test

Serial Number

Press the **RIGHT** arrow to display [instrument serial number](#)

Right ►

Serial Number
0126789

Press **[UTILITY]** to exit Utility Mode and return to [Ready Mode](#)

Connection to Device Under Test (DUT)

Figure COI-1 illustrates the 1910 Inductance Analyzer connected to a device under test using the 4-BNC to 2-Kelvin Clip lead set (QT P/N 1700-03).

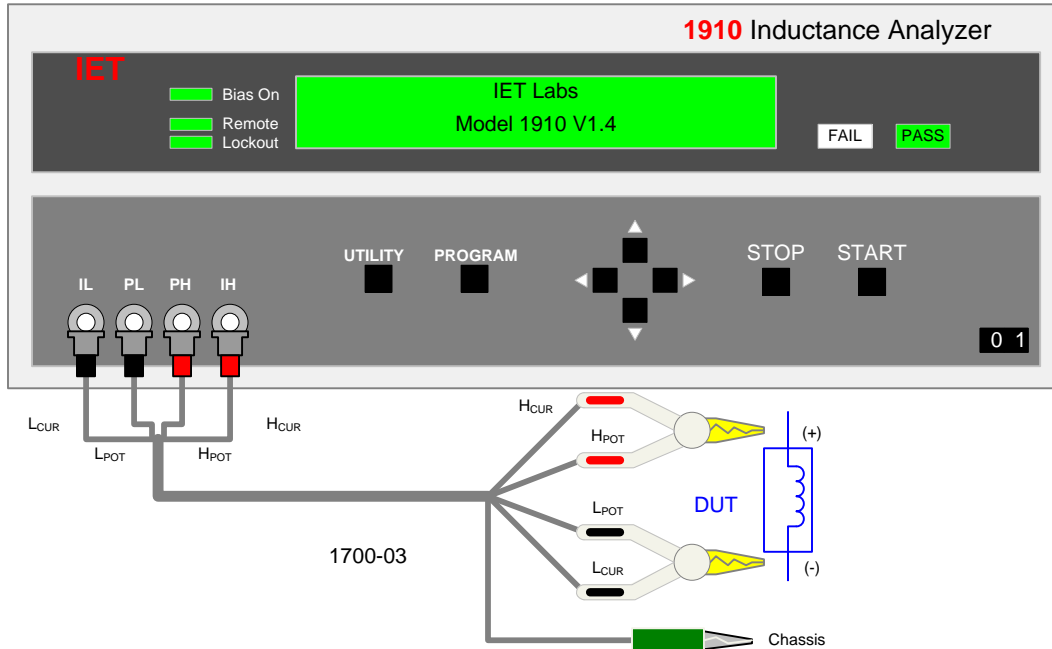

Figure COI-1: Connection to DUT using 1700-03 Kelvin Leads

Connection to the Device under Test (IET Labs. Cables)

Connection as labeled on 1920 front panel	Connections with cables labeled	Connections with cables color coded	Connections with cables color coded
PH connects to	PH or HS	red/white	red
IH connects to	IH or HD	red	red
PL connects to	PL or LS	black/white	black
IL connects to	IL or LD	black	black

Initiating Measurements

- 1) The instrument must be in the **READY** mode, or displaying the results from a previous measurement before initiating a test

```
1  Ls  Rs  1.0000kHz
1.000V No Bias Auto High
```

- 2) Test conditions and Utility functions should be programmed as previously described in this section.

OR

Select the test number by pressing the **Up or Down** arrow key, if known test conditions are already stored in internal memory.

```
6  Prim Param  Ready
Automatic
```

- 3) Make sure the device under test (DUT) is connected to the instrument as previously described.
- 4) To initiate a test on the device press the [START] key.
- 5) The LCD display shows the measured results depending on the operator programming of **Display Type** and **Numeric Format**. Typical display is shown below.

Measured Parameters	<table border="0"> <tr> <td>1</td> <td></td> <td>Ls</td> <td>158.460 uH</td> </tr> <tr> <td>Bin 1</td> <td></td> <td>Q</td> <td>2.4890</td> </tr> </table>	1		Ls	158.460 uH	Bin 1		Q	2.4890	
1		Ls	158.460 uH							
Bin 1		Q	2.4890							
Deviation from Nominal	<table border="0"> <tr> <td>1</td> <td>dev</td> <td>Ls</td> <td>8.460 uH</td> </tr> <tr> <td>Bin 1</td> <td></td> <td>Q</td> <td>0.4890</td> </tr> </table>	1	dev	Ls	8.460 uH	Bin 1		Q	0.4890	
1	dev	Ls	8.460 uH							
Bin 1		Q	0.4890							
% Deviation from Nominal	<table border="0"> <tr> <td>1</td> <td>%dev</td> <td>Ls</td> <td>5.46 %</td> </tr> <tr> <td>Bin 1</td> <td>C</td> <td>Q</td> <td>22.25%</td> </tr> </table>	1	%dev	Ls	5.46 %	Bin 1	C	Q	22.25%	Binning On, Load Correction On
1	%dev	Ls	5.46 %							
Bin 1	C	Q	22.25%							

Other variations of measurement results

Numeric Format = Scientific	<table border="0"> <tr> <td>1</td> <td></td> <td>Ls</td> <td>1.5749e-04 H</td> </tr> <tr> <td>Bin --</td> <td>C</td> <td>Q</td> <td>2.4428</td> </tr> </table>	1		Ls	1.5749e-04 H	Bin --	C	Q	2.4428	Binning Off, Load Correction On
1		Ls	1.5749e-04 H							
Bin --	C	Q	2.4428							

If binning is enabled the Pass or Fail indicator will be lit at the completion of test. Even if binning is not enabled the Pass indicator will still light at the end of the test indicating the test has been completed.

Section 1: Introduction

1.1 Unpacking/Inspection

Inspect the shipping carton before opening. If damaged contact the carrier agent immediately. Inspect the 1910 Inductance Analyzer instrument for any damage. If the instrument appears damaged or fails to meet specifications notify IET Labs. (refer to instruction manual front cover) or its local representative. Retain the shipping carton and packing material for future use such as returning for re-calibration or service.

1.2 Product Overview

The 1910 Inductance Analyzer is designed to perform inductance and a wide variety of impedance measurements on coils, wire wound devices and other electronic components. The 1910 covers a frequency range from 20Hz to 1.0MHz with a basic accuracy of 0.1%. The user can select measurement and display two impedance or voltage parameters simultaneously and select engineering or numeric display of test results as well as deviation or % deviation from a programmed nominal value. The 1910's AC test signal is programmable from 20 mV to 1 V and DC bias current programmable from 0 to 1 A. An external bias current up to 20 A can also be applied to the device under test when using the IET Labs. Model 1320 Bias Current Source.

The 1910 Inductance Analyzer also provides the capability to run up to six different tests in sequence, each with uniquely programmed test conditions and displayed parameters. For pass/fail testing or sorting of parts, the instrument provides 14 programmable bins. For fast component handling or automated system applications the 1910 comes standard with a handler I/O port, RS-232 and IEEE-488 interfaces.

For measurement integrity the 1910 includes four-terminal Kelvin connections and a load correction feature, whereby a measurement is performed on a known standard and a correction applied to subsequent measurements.

1.3 Front Panel Description

Figure 1-1 shows the controls and indicators on the front panel of the 1910 Inductance Analyzer. Table 1-1 identifies them with descriptions and functions.

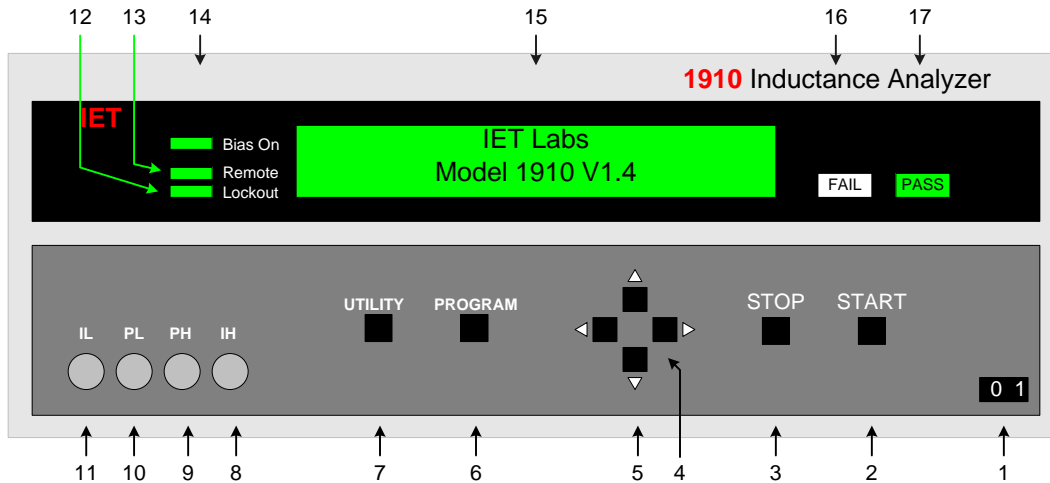

Figure 1-1: Front Panel Controls and Indicators

Table 1-1: Front Panel Controls and Indicators

Reference # Figure 1-1	Name	Type	Function
1	POWER	Rocker Switch	Applies AC power to unit: 1 (ON) 0 (OFF)
2	START	Push Button	Starts a measurement
3	STOP	Push Button	Stops any measurement in process
4		Left/Right arrows	In READY mode moves to the next or previous test parameter for viewing In PROGRAM or UTILITY mode moves to the next or previous parameter for programming
5		Up/Down arrows	In READY mode goes to next or previous test for viewing In PROGRAM or UTILITY mode changes the condition of the selected parameter
6	PROGRAM	Push Button	Enter & exit PROGRAM mode (for changing test conditions)
7	UTILITY.	Push Button	Enter or exit the UTILITY mode (for functional changes which affect all tests)
8	IH	BNC female connector	Current high connection to DUT
9	PH	BNC female connector	Potential high connection to DUT
10	PL	BNC female connector	Potential low connection to DUT
11	IL	BNC female connector	Current low connection to DUT
12	LOCKOUT	Green LED Indicator	Indicates front panel keypad lockout is enabled
13	REMOTE	Green LED Indicator	Indicates instrument has been enabled for remote operation
14	BIAS ON	Green LED Indicator	Indicates internal or external DC is bias applied
15		LCD Display	Indicates programmed test conditions and instrument function or measured test results
16	FAIL	Red LED Indicator	Indicates measured results failed based on programmed limits
17	PASS	Green LED Indicator	Indicates measured results passed based on programmed limits, or test is complete if no limits are programmed

1.4 Rear Panel Description

Figure 1-2 shows the controls and connectors on the rear panel of the 1910 Inductance Analyzer. Table 1-2 identifies them with descriptions and functions.

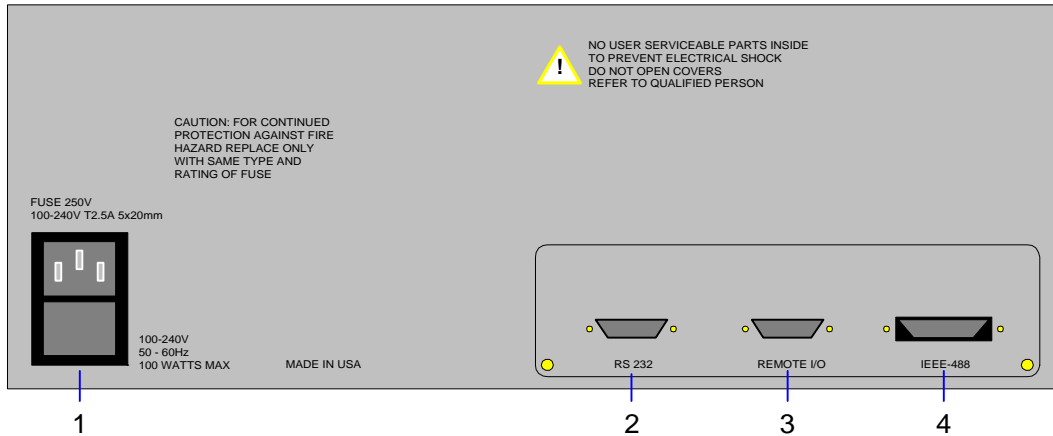

Figure 1-2: Rear Panel View

Table 1-2: 1910 Rear Panel Controls and Connectors

Reference # Figure 1-2	Name	Type	Function
1	AC Inlet Module	3-prong receptacle and fuse draw	Fuse draw and 3-wire connection for AC power Source. 2.5A, 250V fuse for 100-240 volt operation
2	RS-232	9 pin DB-Type connector	Input/Output connections for RS-232 interface
3	Remote I/O	37 pin DB-Type connector	Input/Output connections for handler interface
4	IEEE-488	24 pin connector	Input/Output connections for IEEE-488 interface

NOTE:

User cable specifications for use with CE Mark 1910

- RS-232 Shielded cable required
- Remote I/O Cable must be double shielded (inner braid and outer foil)
- IEEE-488 Shielded cable required

1.5 Installation

1.5.1 Dimensions

The 1910 Inductance Analyzer is supplied in a bench configuration, i.e. in a cabinet with resilient feet for placement on a table or bench. Figure 1.3 illustrates the 1910 instrument dimensions. The unit can be configured for rack mount applications using the 2000-16 optional Rack Mount Flanges.

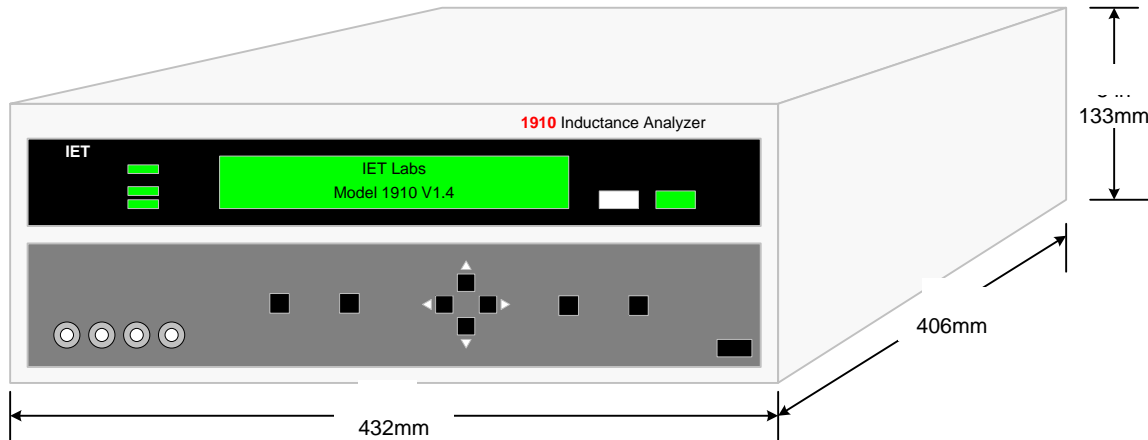



Figure 1-3: Instrument Dimensions

1.5.2 Instrument Positioning

The front panel includes a high resolution back lit LCD display. A front bail is provided so that the unit can be tilted back for convenient operator viewing. The optimum angle for viewing is straight onto the display. This means that for bench or rack operation the instrument should be positioned at eye level.

1.5.3 Power Requirements

 The 1910 can be operated from a power source between 100 and 240Vac at a power line frequency of 50 to 60Hz, no line voltage switching is necessary. Power connection to the rear panel is through an AC inlet module comprised of an AC connector and fuse drawer. Before connecting the 3-wire power cord between the unit and AC power the fuses should be in accordance with the power source, T2.5A, 250V, 5x20mm (IET Labs. PN 520049) for 115 or 220V source. Always use an outlet which has a properly connected protection ground. **The instrument is factory shipped with the 2.5A fuse in place. The instrument can be damaged if the wrong fuse is installed.**

Procedure for changing fuse

WARNING
MAKE SURE THE UNIT HAS BEEN DISCONNECTED FROM ITS AC POWER SOURCE FOR AT LEAST FIVE MINUTES BEFORE PROCEEDING.

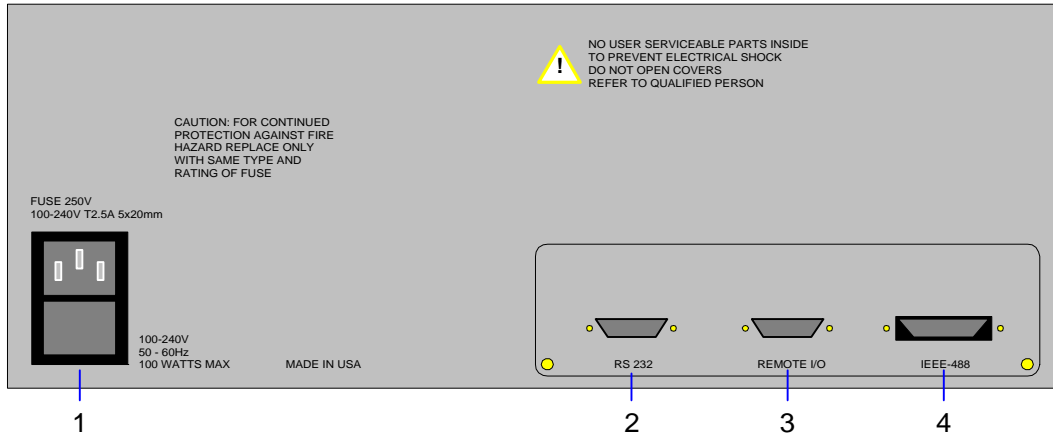

Figure 1-4: Fuse Drawer Location

Remove the **fuse drawer** by inserting a small flat head screwdriver behind the small tab to force the draw outward. Refer to Figure 1-4.

Once the fuse drawer has been completely removed from the instrument remove the **clear fuse tray** from the drawer by lifting upward slightly on the long narrow black locking tab. This will allow the fuse tray to be removed from the fuse drawer. This tray contains the active fuse, left side (secured by holder) and spare fuse on the right side (if present). Refer to Figure 1-5 for fuse drawer detail.

Remove the active fuse from the holder by prying upward using a small flat head screwdriver. Insert the replacement fuse into the fuse holder.

Once the fuse has been installed in the holder and spare fuse (if desired) installed in the right side of the tray insert the tray back into the fuse drawer, push in and lock. The two silver contacts on the fuse tray should be positioned towards the outside.

Once the fuse tray has been installed in the drawer, reinstall the fuse drawer back into the instrument AC inlet module, push in and lock.

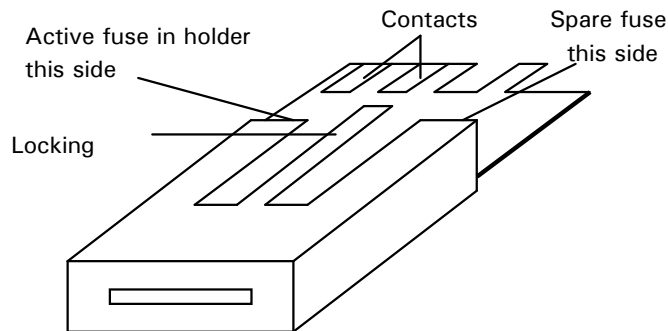

Figure 1-5: Fuse Drawer Detail

1.5.4 Safety Inspection



Before operating the instrument, inspect the power inlet module or the rear panel to ensure that the **properly rated fuse is in place**, otherwise damage to the unit is possible. Refer to paragraph 1.5.3.

The instrument is shipped with a standard U.S. power cord, IET Labs. P/N 4200-0300 (with Belden SPH-386 socket or equivalent, and 3-wire plug conforming to IEC 320). Make sure the instrument is only used with these cables (or other approved international cord set) which ensures that the instrument is provided with **connection to protective earth ground**.

The surrounding environment should be **free from excessive dust** to prevent contamination of electronic circuits. The surrounding environment should also be **free from excessive vibration**. The instrument should be positioned with consideration for ample air flow to the rear panel ventilation holes, an open space of at least 75mm (3 inches) is recommended behind the rear panel. Do not expose the instrument to direct sunlight, extreme temperature or humidity variations, or corrosive chemicals.

When the 1910 is used in a rack installation (using the IET Labs. 2000-16 Rack Mount Flanges) make sure the unit is **secured using rack cabinet mounting rails**, and not secured solely by these front panel flanges.

Section 2: Operation/Programming

2.1 Terms and Conventions

Table 2-1: Measurement Unit Prefixes

<u>Multiple</u>	<u>Scientific</u>	<u>Engineering</u>	<u>Symbol</u>
1000000000000000	10 ¹⁵	Peta	P
1000000000000	10 ¹²	Tera	T
1000000000	10 ⁹	Giga	G
1000000	10 ⁶	Mega	M
1000	10 ³	Kilo	k
.001	10 ⁻³	milli	m
.000001	10 ⁻⁶	micro	μ
.000000001	10 ⁻⁹	nano	n
.000000000001	10 ⁻¹²	pico	p
.000000000000001	10 ⁻¹⁵	femto	f

Frequency: The rate at which current or voltage reverses polarity and then back again completing a Full cycle, measured in Hertz (Hz) or cycles/second. AC Line Frequency = 50/60 Hz.

Ground: The base reference from which voltages are measured, nominally the same potential as the earth. Also the side of a circuit that is at the same potential as the base reference.

Inductance: Inductance is the property of a coil to oppose any change in current through it. The inductance of a coil varies as the number of turns squared (N²). If the turns are stretched out, the field intensity will be less and the inductance will be less. The larger the radius or diameter of the coil, the longer the wire used and the greater the inductance.

Inductive Reactance: A measure of how much the counter electro-magnetic force (EMF) of the coil will oppose current variations. The amount of reactance is directly proportional to the frequency of the current variation.

$$X_L = 2\pi fL$$

Quality Factor: Quality factor is a measurement of the quality of an inductor: how tight the wire is wrapped (wound). The higher the Q the better the inductor. Q is equal to reactance divided by resistance. $Q = X_S / R_S$

Capacitance:	The ratio of charge on either plate of a capacitor to the potential difference (voltage) across the plates. When a voltage is applied, current flows immediately at a high rate then exponentially decays toward zero as the charge builds up. If an AC voltage is applied, an AC current appears to flow continuously because the polarity of the voltage is reversed at the frequency of the applied voltage. The waveform of this current however is displaced in time from the applied voltage by 90°.
Capacitive Reactance:	A measurement of the actual AC resistance of a capacitor. How effective a capacitor may be in allowing AC to flow depends upon its capacitance and the frequency used. $XC = 1 / 2\pi fC$.
Dissipation Factor:	Dissipation factor is a measurement of the quality of a capacitor: how well it dissipates charge. The lower the D_f , the better the capacitor. Dissipation factor is equal to resistance divided by reactance. $D_f = R_S / X_S = 1/Q = \tan(90^\circ - \theta) = \tan\delta$.
Impedance:	In AC circuits, impedance is the “AC resistance” to the flow of current through a circuit when an AC voltage is applied across the terminals of that circuit. Impedance is composed of real (in phase with voltage) and reactive (out of phase by 90°) components. $Z = E/I = R + jX$ Impedance = resistance + reactance.
Series Circuit:	Designated with a subscript S in equations and Figure 2-1.
Parallel Circuit:	Designated with a subscript P in equations and Figure 2-1.
Nominal Value:	Value inputted by operator. The display will show deviation or % deviation of the DUT from the Nominal Value.
Dielectric Absorption:	The physical phenomenon in which insulation appears to absorb and retain an electrical charge slowly over time. Apply a voltage to a capacitor for an extended period of time, then quickly discharge it to zero voltage. Leave the capacitor open circuited for a period of time then connect a voltmeter to it and measure the residual voltage. The residual voltage is caused by the dielectric absorption of the capacitor.

2.2 Power Up

Once the 1910 is powered up it is ready for immediate testing if test conditions have been previously stored in one of the internal memory locations (user tests 1 thru 30). Any of these test conditions and other instrument settings can be changed by easy-to-use menu functions. For use of the functions refer to the Condensed Operating Instructions in the front of this manual and for more detailed descriptions and uses of these functions refer to Program/Setup procedure which follows.

Connect the power cord (female end) to the AC inlet module on the rear panel of the instrument. Connect the other end (male end) to the power receptacle. **The instrument is to be used only with three wire grounded outlets, 115 or 230V, no line voltage switching is required.**

WARNING
DO NOT TURN INSTRUMENT POWER ON OR OFF WITH TEST DEVICES CONNECTED.

Power is applied to the 1910 by pressing the front panel **POWER** switch to **ON** (1 position). The instrument sequences through a initialization routine, display of operating software version, and to the Ready mode of the test setup # in which a measurement was made before the unit was last powered down.

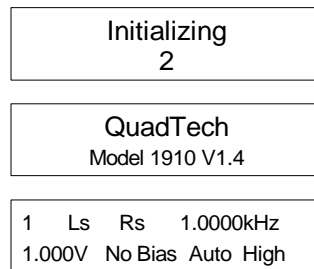

2.3 Program/Setup Procedure (Test 1-30)

Figure 2-1 illustrates the typical display after the 1910 powers up and initializes its circuitry.

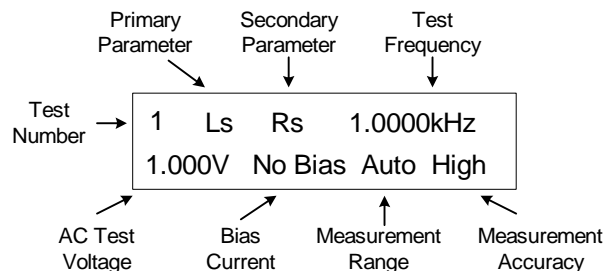

Figure 2-1: Typical Display

The display illustrated in Figure 2-1 is typical on power-up, with the programmed test conditions shown for setup # 1, in the Ready state.

To view programmed setups

To select any test setup number for viewing simply press the **Up or Down** arrow keys while in the Ready state (user test 1-30, or sequence S1-S9) and press **Right** arrow key to view individual test parameters. Sequence tests (S1-S9) can be any combination of user tests (up to a maximum of 6), these are discussed in paragraph 2.4.

To program setups

Select the desired test setup number by pressing the **Up or Down** arrow keys while in the Ready state shown above, then press the **PROGRAM** key to enter the program mode.

Program mode can be exited at any time and instrument returned to Ready state by pressing PROGRAM key or program mode is exited automatically after sequencing through all test parameters with Right arrow key.

Programmable functions are discussed below.

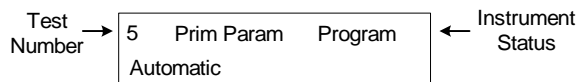

2.3.1 Primary Parameter

Any combination of two ac parameters, or two dc parameters, can be measured and displayed simultaneously on the 1910, one referred to as the **Primary** (displayed first) and the other the **Secondary** (see paragraph 2.3.2). The instrument can be set for a primary parameter selection of Auto, a feature which enables any passive component to be measured without knowing what type of component it is. The parameter selection can be chosen by the operator through menu selection as shown below.

Up or Down  arrow key to select parameter of choice

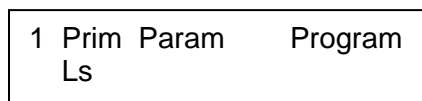
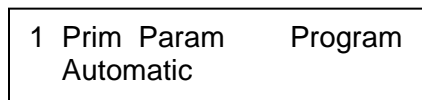

Ls thru DCI

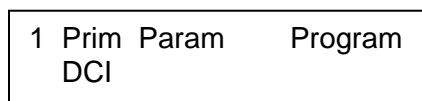

Right  arrow key to program next parameter

or

PROGRAM key to exit Program Mode and return to Ready mode.

The following selections are possible and discussed in more detail below.

L_s - Inductance in henries
 L_p - Inductance in henries
 R_s - Resistance in ohms
 R_p - Resistance in ohms
 C_s - Capacitance in farads
 C_p - Capacitance in farads
 DF- Dissipation Factor (no units)
 Q - Quality Factor (no units)
 $|Z|$ - Impedance in ohms
 $|Y|$ - Admittance in siemens

P - Phase Angle in degrees
 $|ESR|$ -Equivalent series resistance in ohms
 G_p - Conductance in siemens
 X_s - Reactance in ohms
 B_p - Susceptance in siemens
 V - AC voltage across the DUT
 I - AC current thru the DUT
 DCV - DC voltage across the DUT
 DCR - DC resistance in ohms
 DCI - DC current thru the DUT

s = series equivalent circuit
 p = parallel equivalent circuit

An impedance that is neither a pure resistance nor a pure reactance can be represented at any specific frequency by either a series or a parallel combination (s or p) of resistance and reactance. Such a representation is called an equivalent circuit. The value of the primary measurement of a device depends on which equivalent circuit, series or parallel, is chosen to represent it. The manufacturer or user of a device specifies how a device is to be measured (usually series) and at what frequency. If this is not known, be sure to specify if the results were series or parallel and what the measurement frequency was. Series and parallel equivalent circuits for a lossy inductor and lossy capacitor are shown in Figure 2-2.

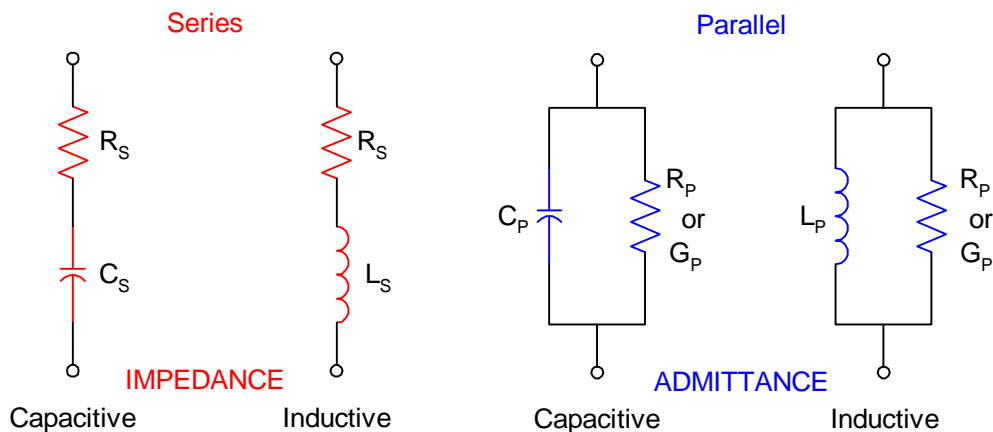

Figure 2-2:
Series and Parallel Circuits for both Capacitive and Inductive Impedances

Impedance is the parameter used to characterize electronic components, materials and circuits. Impedance $|Z|$ is defined as the opposition a device or circuit offers to the flow of ac current at a particular frequency and generally represented as a complex quantity consisting of a real part (resistance, R) and imaginary part (reactance, jX). Impedance can be expressed using the rectangular coordinate form ($R + jX$) or polar form as magnitude and phase angle ($|Z| \angle \theta$). Figure 2-3a shows the mathematical relationship between R , X , $|Z|$, and θ for both inductive and capacitive devices. In some cases it becomes mathematically practical to represent impedance using the reciprocal where $1/|Z| = |Y| = G + jB$, where $|Y|$ represents admittance, G conductance, and B susceptance. This mathematical relationship is shown in Figure 2-3b for inductive and capacitive devices.

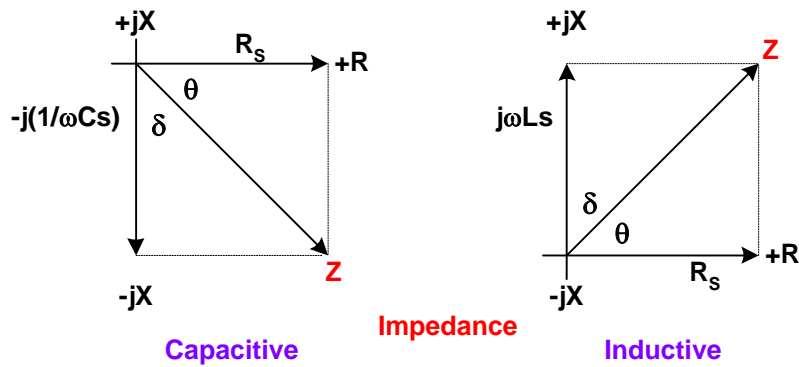

Figure 2-3a: Phase Diagrams of Impedances

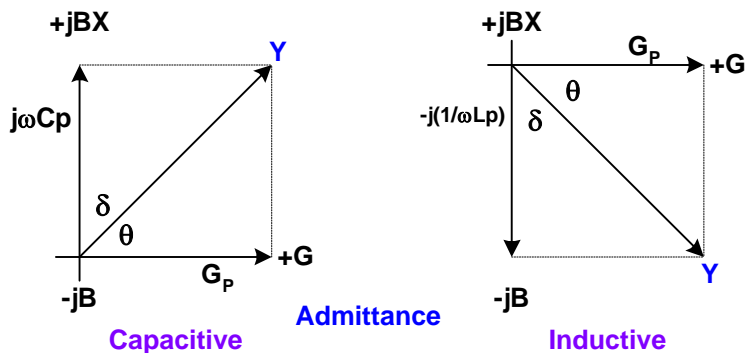

Figure 2-3b: Phase Diagrams of Admittances

Quality factor (Q) is used as a measure of a reactance's purity (how close it is to being a pure reactance, i.e. no resistance) and defined as the ratio of the energy stored in a device to the energy dissipated by the device. Q is dimensionless and is expressed as $Q = X/R = B/G$. From Figure 2-3 one can see that Q is the tangent of the angle θ . Q is commonly applied to inductors and for capacitors the term generally used to express purity is Dissipation Factor (D), which is the reciprocal of Q.

2.3.2 Secondary Parameter

(not shown if Primary Parameter selected for Automatic)

As in the primary parameter selection the secondary parameter can be chosen by the operator for display. When the primary parameter is selected for Automatic the secondary is determined by it. For example, if the primary display is selected for capacitance (C) the secondary defaults to dissipation factor (D) or for a primary of inductance (L) the secondary defaults to quality factor (Q). The following secondary parameters may be chosen:

No Secondary Param, Ls, Lp, Rs, Rp, Cs, Cp, DF, Q, Z, Y, P, ESR, Gp, Xs, Bp, V, I

Up or Down  arrow key
to select parameter of choice

1 Sec Param	Program
No secondary param	

1 Sec Param	Program
Ls	

Ls thru I

1 Sec Param	Program
I	

Right  arrow key to program
next parameter

or

PROGRAM key to exit Program
Mode and return to Ready mode.

2.3.3 Frequency

(not shown if Primary Parameter selected for DCV, DCR or DCI)

This function allows the user to program the frequency of the AC test signal between 20Hz and 1MHz using two different methods. When the Utility function **Freq. Edit Type** is selected for **Discrete**, selection is made from 15 possible frequencies selections over this range, or when **Freq. Edit Type** is selected for Continuous, the frequency can be selected in increments of 1Hz below 100kHz and increments of 10Hz above 100kHz. Refer to Utility functions, paragraph 2.5 for information on the frequency edit type. When discrete is selected the 16 possible frequencies are: 20, 50, 100, 200, 400, 500Hz, 1, 2, 5, 10, 20, 50, 100, 200, 500kHz, and 1MHz

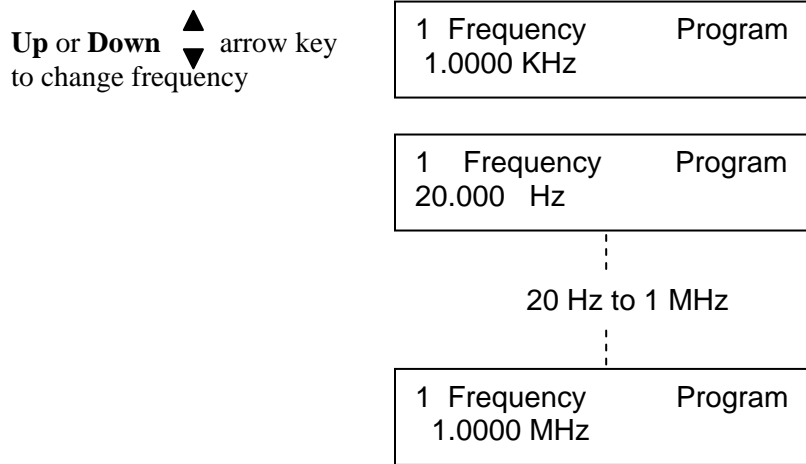

Right ► arrow key to program
next parameter

or

PROGRAM key to exit Program
Mode and return to Ready mode.

2.3.4 Amplitude

This function allows the user to program the ac test voltage amplitude between 20 mV and 1.0000 V in 5 mV steps. The programmed voltage is maintained at the instrument terminals with the terminals open, but not necessarily at the DUT. The actual voltage across the DUT is never more than the programmed voltage, and depends on the DUT impedance and source resistance of the 1910, which can be 5Ω, 25Ω 50Ω or 100Ω. Refer to Utility functions, paragraph 2.5.6 for information on the source impedance. The instrument source resistance must be taken into consideration especially when measuring low values of impedance (low inductance or high capacitance). For example, if the programmed amplitude voltage is 1V, the source resistance set for 50Ω, and the impedance of the unknown DUT 50Ω, the voltage across the DUT is not 1V but rather 0.5V.

Up or Down ▲
to change voltage ▼ arrow key

1	Amplitude	Program
	1.0000 V	

2	Amplitude	Program
	1.00 mV	

1 mV to 1 V

1	Amplitude	Program
	1.0000 V	

Right ► arrow key to program next parameter

or

PROGRAM key to exit Program Mode and return to Ready mode.

2.3.5 Bias Current

This function allows the user to program DC bias current to **Off** or from **1mA to 1A** in 1mA steps with a maximum compliance voltage of 10V, i.e. (I) times (R) must be less than 10 volts. When selected for Off no bias current is applied to the device under test, when programmed for a bias current this DC current flows to the device under test.

NOTE:

When using the 1910 (in external bias mode) with the IET Labs. 1320 DC Bias Current Source, the Bias Current must be set to OFF and the 1320 set to Handler mode. Refer to the 1320 instruction manual. Connect the 1910 input BNC's (4) to the 1320 FROM L METER BNC's (4), using BNC to BNC cable. Connect 1910 rear panel REMOTE I/O to the 1320 HANDLER INTERFACE using a 1320-07 interconnect cable.

Up or Down ▲
to change bias current ▼ arrow key

1	Bias Current	Program
	Off	

1	Bias Current	Program
	1.00 mA	

1 mA to 1 A

1	Bias Current	Program
	1.0000 A	

Right ► arrow key to program next parameter

or

PROGRAM key to exit Program Mode and return to Ready mode.

2.3.6 Range Select

This function allows the user to manually select a measurement range. There are 27 current/voltage range combinations (45 for DC), but the test frequency will determine which ranges are selectable. **To eliminate operator errors in range setting and ensure specified instrument accuracy it is generally best to set the range for Auto.** When Auto is selected the instrument automatically selects the optimum range for the impedance being measured at the selected test voltage and frequency.

Range Hold, when selected, will hold the optimum measurement range for the test conditions programmed and the device being measured. The unit determines the selection on the first measurement by measuring the device in Auto range mode and then holding it.

Range Lock, allows the operator to select one of the fixed ranges as listed below.

In either case, it is important to note that when a range is held or locked which is not the range that instrument's auto ranging would of selected (for DUT impedance and programmed test conditions) some accuracy may be sacrificed or the instrument may be unable to complete a test of a particular DUT.

Up or Down ▲▼ arrow key to change range

1 Range Select	Program
Auto	

1 Range Select	Program
Hold	

1 Range Select	Program
Lock 200 mA, any F 1.0V	

⋮
27 ranges (45 for DC)

1 Range Select	Program
Lock 2.6µA F<=10K 62 mV	

Right ► arrow key to program next parameter

or

PROGRAM key to exit Program Mode and return to Ready mode.

Table 2-2: Manual Range Selection

	AC Impedance Measurements		DCR&DCV Measurements
Maximum Measurable Voltage Across DUT	Maximum Measurable AC Current to DUT	User Programmed Test Frequency	Maximum Measurable DC Current to DUT
$V_{MEASURE}$	$I_{MEASURE (AC)}$	$F_{PROGRAMMED}$	$I_{MEASURE (DC)}$
(1 V)	200mA	20Hz to 1 MHz	200mA
	40mA	20Hz to 1 MHz	40mA
	10mA	20Hz to 1 MHz	10mA
	2.67mA	20Hz to 1 MHz	2.67mA
	668 μ A	20Hz to 1 MHz	668 μ A
	167 μ A	20Hz to \leq 250 kHz	167 μ A
	42 μ A	20Hz to \leq 250 kHz	42 μ A
	11 μ A	20Hz to \leq 10 kHz	11 μ A
2.6 μ A	20Hz to \leq 10 kHz	2.6 μ A	
250mV	7 ranges as listed above	7 ranges as listed above	7 ranges as listed above
62mV	7 ranges as listed above (200mA range not recommended)	7 ranges as listed above	7 ranges as listed above (200mA range not recommended)
22mV			7 ranges as listed above (200mA range not recommended)
6mV			7 ranges as listed above (200mA and 40mA range not recommended)

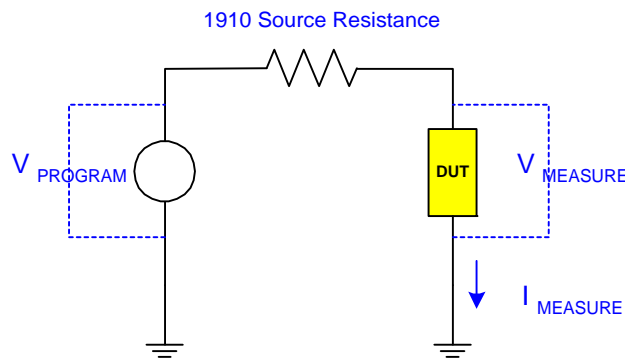

NOTE:
 The best way to determine the optimum range for a test device at programmed conditions is to change the primary parameter selection to V (AC voltage across the device), secondary parameter to I (current through the device), and initiate a test. The voltage and current measured can be compared to the previous table where the appropriate range is determined with the measured values falling below the maximums listed

2.3.7 Accuracy

This function allows the user to program four possible settings for measurement accuracy, **Low, Medium, High or Low (No Display)**. Note, that when programmed for Low No Display, measurement data is not available via IEEE-488 or RS-232 interfaces, but only available as binning data through the Remote I/O interface. The instrument will make a more precise measurement when programmed for High, but there is a tradeoff in measurement speed as indicated in Table 2-3.

Table 2-3: 1910 Accuracy

Accuracy Setting	Measure Time	Measure Speed	Nominal Accuracy
Low	40 ms	25 meas/sec	0.5%
Medium	100 ms	10 meas/sec	0.25%
High	1 s	1 meas/sec	0.1%
Low (No Display)	25 ms	40 meas/sec	0.5%

NOTE:

Measurement times may be longer depending on frequency and other test conditions. One complete cycle of stimulus voltage is required for measurement.

Up or Down  arrow key
to change accuracy

1 Accuracy Program
Low (40ms test)

1 Accuracy Program
Medium (100 ms test)

1 Accuracy Program
High (1 second test)

1 Accuracy Program
Low, No Display (25ms)

Right  arrow key to program
next parameter

or

PROGRAM key to exit Program
Mode and return to Ready mode.

The 1910 has three basic accuracies:

Basic Accuracy For AC:

High 0.10%

Medium 0.25%

Low & Low No Display 0.5%

The actual accuracy at a given test condition is defined by the following formula:

$$\text{Accuracy} = \text{Acc}_{\text{Basic}} \sqrt[3]{\frac{1}{V} \left[\left(1 + \frac{50}{\text{Freq}} + \frac{\text{Freq}}{200\text{k}} \right) \left[1 + \frac{|Z|}{Z_{\text{Max}}} + \frac{1}{|Z|} \right] \right]}$$

V = Programmed test voltage (V_{SOURCE})

Freq = Programmed test frequency

|Z| = DUT impedance

Note: For frequencies above 100kHz V_{DUT} must be at least 20mV. That is

$$V_{\text{DUT}} = V_{\text{SOURCE}} \left(\frac{Z_{\text{DUT}}}{Z_{\text{DUT}} + R_{\text{SOURCE}}} \right)$$

Z_{Max} is 4*10⁵ for Frequency less than 10kHz
 2.5*10⁴ for Frequency less than 250kHz
 1.5*10³ for Frequency above 250kHz

$$\text{DF}_{\text{ACCURACY}} = \left[\frac{\text{Accuracy \%}}{100} + \frac{\text{DF}}{50} \right] \left[1 + \sqrt{\frac{\text{Freq}}{50000}} \right]$$

$$\text{Q}_{\text{ACCURACY}} = \left[\frac{\text{Accuracy \%}}{100} \right] + \left[|Q| \left[0.02 + \frac{\text{Accuracy \%}}{100} \right] \right] + \left[Q^2 \left[\frac{\text{Accuracy \%}}{200} \right] \right]$$

Basic Accuracy For DC:

High 0.20%

Medium 0.25%

Low & Low No Display 0.5%

$$\text{Accuracy} = \text{Acc}_{\text{Basic}} \sqrt[3]{\frac{1}{V} \left(1 + \frac{0.3}{R} + \frac{R}{R_{\text{Max}}} \right)}$$

R = DC Resistance R_{Max} = 400kΩ

Due to the large time constants involved in measurements of high value inductors, additional inaccuracies may result. This will be indicated by reduced display resolution.

For Capacitors If DF > .1

For Inductors if Q < 10

$$\text{Accuracy} = \text{Accuracy} \sqrt{1 + \text{DF}^2}$$

$$\text{Accuracy} = \text{Accuracy} \sqrt{1 + \left(\frac{1}{Q} \right)^2}$$

Temperature: Error doubles for every 10°C from 23°C

Additional Impedance Error ($|Z|$) with Current Bias:

$$|Z| = \text{Accuracy} * (1 + E_Z + E_F)$$

E_Z = UNKNOWN impedance factor error

E_F = Instrument frequency factor error

If $Q < 10$, multiply $|Z|$ by $(1 + 1/Q)$

Unknown Impedance Factor (E_Z)

UNKNOWN Impedance (Ω)	- 1 Ω	1 - 1k Ω	1k Ω - 100k Ω
E_Z	$5 \log 1/ Z $	0	$5 (\log Z - 3)$

Instrument Frequency Factor (E_F)

Frequency Range (Hz)	20 - 100Hz	100 - 1kHz	1k - 100kHz	100k - 300kHz	300k - 1MHz
E_F	3	1	0	1	3

Additional Impedance Error (Z_L) due to inductance:

$$|Z_L| = 2\pi fL$$

f = measurement frequency

L = measured inductance

Additional Phase Angle Error (θE)

$$\theta E = \frac{ZE [\%]}{\pi (100)} [^\circ]$$

Additional Quality Factor Error (QE)

$$QE = \pm \frac{[\tan\theta E (1 - Q^2)]}{(1 - Q \tan\theta E)}$$

When $Q < 10$, multiply QE by $(1 + 1/Q)$

Example of Additional Error Calculation

Calculate the added L-Q error.

Measuring Conditions:

Inductance: 1mH
 Quality Factor: 20
 Measurement Frequency: 10kHz
 DC Bias Current: 1A

1. Calculate Impedance ($|Z_L|$) to obtain Inductance error (LE)
 $|Z_L| = 2\pi \times 10k \times 1mH = 62.8$

Check Tables: $E_Z = 0, E_F = 0$

$$LE = \left| \frac{Z}{Z} \right| = \text{Accuracy} (1 + E_Z + E_F)$$

$$LE = \left| \frac{Z}{Z} \right| = \text{Accuracy} (1 + 0 + 0)$$

$$LE = \left| \frac{Z}{Z} \right| = \text{Accuracy} (1)$$

$$LE = \left| \frac{Z}{Z} \right| = \text{Accuracy}$$

2. Phase Angle (θE)

$$\theta E = \frac{ZE [\%]}{\pi (100)} [^\circ] \qquad \theta E = \frac{80 [\pm 1]}{\pi (100)} [^\circ] \qquad \theta E = \pm 0.573^\circ$$

3. Quality Factor (QE)

$$QE = \pm \frac{[\tan\theta E (1 + Q^2)]}{(1 - Q \tan\theta E)} \qquad QE = \frac{[.01 \times 401]}{[(1-20 \times .01)]} \qquad QE = \pm 5$$

2.3.8 Delay

This function allows the user to program a delay time between **0 and 100 s** in 10 ms steps. This is a programmable delay time from the internal or external trigger command to the start of the measurement. In many cases it is helpful to have a time delay before actually making measurements. Such a delay allows time for switching transients or mechanical handling to settle.

Up or Down \blacktriangle \blacktriangledown arrow key
to change delay time

1 Delay Off	Program
----------------	---------

1 Delay 10.00 ms	Program
---------------------	---------

10 ms to 100 s

1 Delay 100.000 sec	Program
------------------------	---------

Right \blacktriangleright arrow key to program
next parameter

or

PROGRAM key to exit Program
Mode and return to Ready mode.

2.3.9 No. to Average

This function allows the user to program the number of measurements to average between **1 and 999**. If the entered value is 1, averaging is disabled and the display is updated with each individual measurement. If the entered average is 10 the instrument will make 10 measurements and then display the average value. When the instrument is in a continuous measurement mode the display is retained until the next average of 10 is complete. Averaging improves the measurement accuracy over the single measurement accuracy by $\frac{1}{\sqrt{n}}$, but never less than 0.1% for the parameter and 0.1% or 0.001 for the secondary. n = no. to average.

Up or Down  arrow key
to change # to average

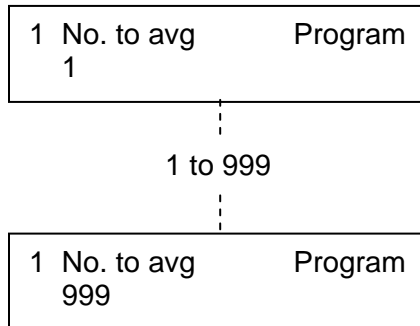

Right  arrow key to program
next parameter

or

PROGRAM key to exit Program
Mode and return to Ready mode.

2.3.10 Primary Nominal

The Primary Nominal value (programmable by the operator) can serve as a basis for three functions:

- 1) The nominal value for the primary binning functions. Refer to paragraph 2.3.11.
- 2) The nominal value for calculating Deviation or % Deviation when the measurement results are programmed to be display in this format. Refer to paragraph 2.5.3.
- 3) The nominal value (or actual known value) when implementing the load correction feature of the 1910. Refer to paragraph 2.3.13.

This function allows the user to select a nominal value for the primary displayed parameter, selection of nominal value for the secondary parameter is discussed in paragraph 2.3.12. One technique for determining the approximate nominal values (or starting point) is to first measure the DUT and then fine tune as indicated below. The units for the nominal value (Ω , mH, μ F, etc.) are determined by operator selection of the Primary Parameter.

Up or Down  arrow key
to change nominal value

or

With DUT connected,
press **START** to determine
approximate nominal value
from measurement of DUT
and then Up or Down 
arrow key to fine tune

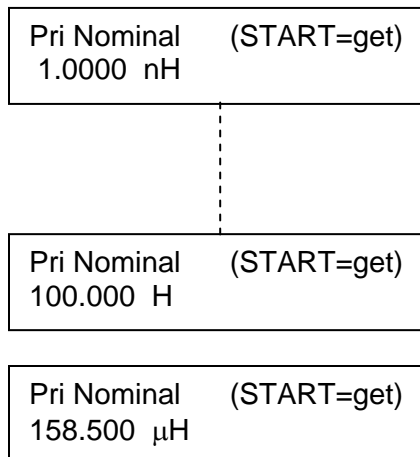

Right  arrow key to program
next parameter

or

PROGRAM key to exit Program
Mode and return to Ready mode.

2.3.11 Bin Type

A group of similar components can be measured and categorized according to operator programmed limits. For example, the 1910 can be used to sort a group of nominally-valued 100 kΩ resistors into assigned bins of 1%, 2%, 5%, etc., around a nominal value, or sorted by absolute limits which are independent of any nominal value. The 1910 provides sorting capability into 14 bins (10 pass and 4 fail). These are assigned as follows:

Bins 1 thru 10	Primary pass, secondary pass (if limit is entered)
Bin 11	Primary pass, secondary fail low
Bin 12	Primary pass, secondary fail high
Bin 13	Primary fail, secondary pass
Bin 14	Primary fail, secondary fail

If no limit is entered for the primary parameter but one is entered for the secondary, bin assignment will be Bin 1 for a pass and Bin 11 for a fail low and Bin 12 for a fail high.

Bin limits for the primary parameter can be entered in terms of absolute value or as a percent tolerance about a defined nominal. Two of the most common methods of sorting are **nested** limits and **sequential** limits. Nested limits are a natural choice for sorting by % tolerance around a single nominal value with the lower numbered bins narrower than the higher numbered ones. Nested limits for five bins are illustrated below, note that limits do not have to be symmetrical as shown for bin 5, which is +20% and -30%. When entering limits in percent, both can be positive, both can be negative, or one can be positive and one can be negative, but the Hi limit must be more positive than the Lo limit.

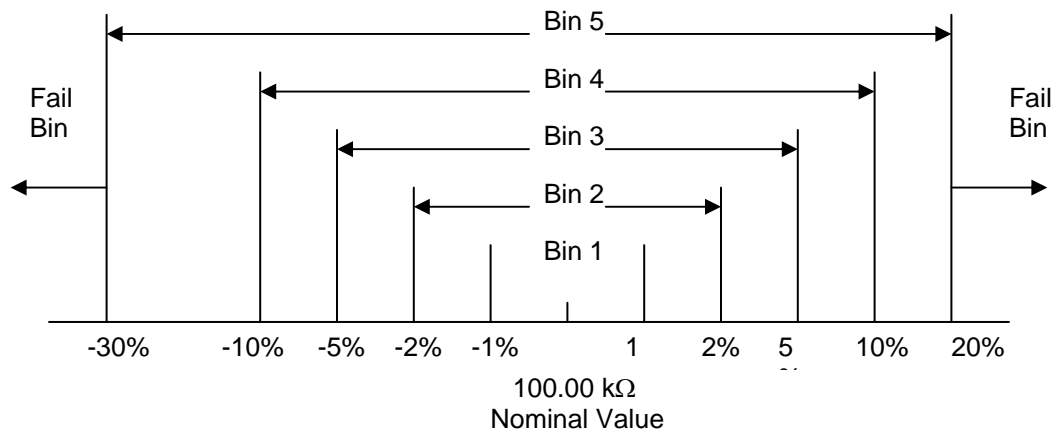

Sequential limits are a natural choice for sorting by absolute value. Sequential limits for four bins are illustrated below. It should be noted that the bins do not necessarily have to be adjacent. Depending on the specified limits for each they can be overlapping, adjacent or even isolated (gaps) from each other. Any overlap is assigned to the lower numbered bin and a gap would be assigned to the overall fail bin.

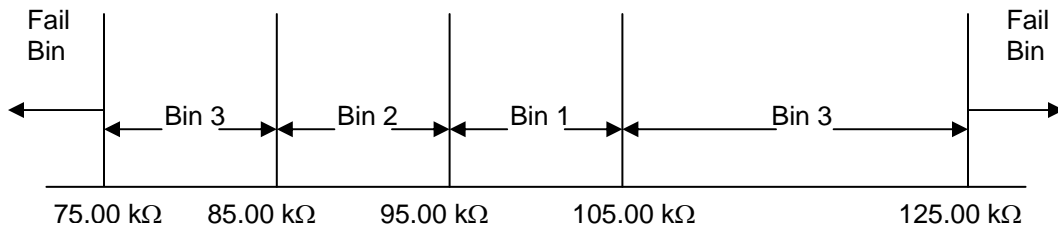

Up or Down  arrow key
to change bin type

1 Bin Type	Program
Off	

1 Bin Type	Program
Pct. Deviation	

Right  arrow key to
select bin 1 limits in %

1 Bin 1 HiLim	Program
Off %	

Up or Down  arrow
key to change bin 1
Hi % limit

1 Bin 1 HiLim	Program
200.00 %	

Note:

To set a Hi and Lo limit to **Off**,

Up or Down  arrow to change
one of the limits to the value entered
for its counterpart. For example:

If the Absolute HiLim is 110Ω and
LoLim is 90Ω (or % deviation limits
are +10% and -10%)

Down  arrow the HiLim to 90Ω
(or -10%) to select **Off**

200% to -100%

1 Bin 1 HiLim	Program
- 100.00 %	

Right  arrow key to

1 Bin 1 LoLim	Program
Off	

Up or Down  arrow
key to change bin 1
Lo % limit

1 Bin 1 LoLim	Program
200.00 %	

200% to -100%

1 Bin 1 LoLim	Program
- 100.00 %	

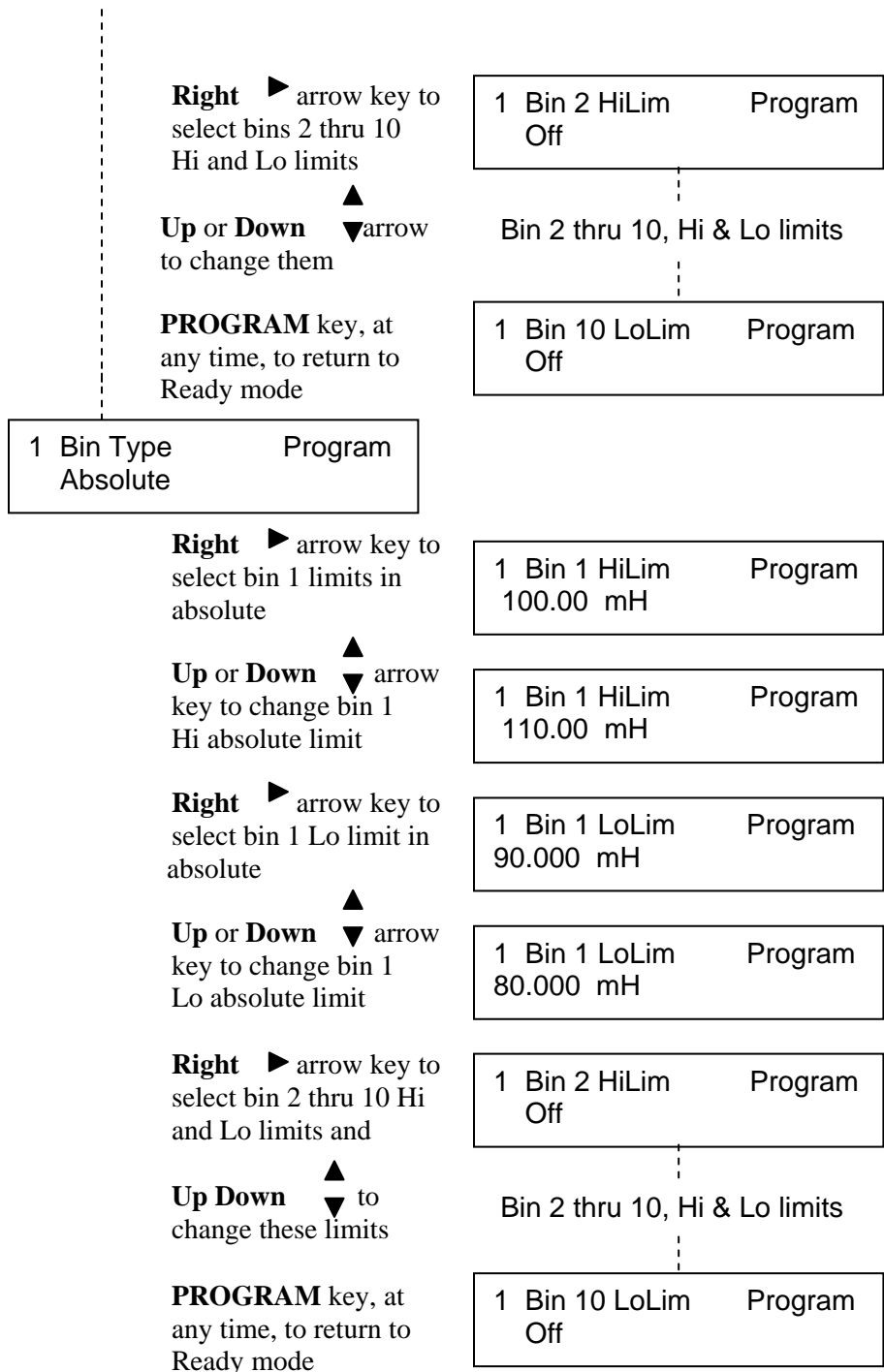

Right ► arrow key to program next parameter
or
PROGRAM key to exit Program Mode and return to Ready mode.

2.3.12 Secondary Nominal

(not shown if Secondary Parameter is set to “No Secondary parameter”)

This function allows the user to select a nominal value for the secondary displayed parameter and to program high and low limits around this nominal. These limits are selected in absolute value or % deviation about this nominal (determined by bin type selection, refer to paragraph 2.3.11). The limits do not have to be symmetrical; there is an independent limit for both the high and low values. The units for the nominal value (Ω , mH, μ F, or absolute value) are determined by operator selection of the Secondary Parameter.

Up or Down  arrow key
to enter change value

1 Sec Nominal	Program
1.0000	

1 Sec Nominal	Program
10.000	

Right  arrow key to
select secondary limits

1 Sec HiDev	Program
1.0000	

Up or Down  arrow
key to change secondary
parameter Hi limit

1 Sec HiDev	Program
12.000	

Right  arrow key to
select secondary
parameter Lo limit

1 Sec LoLim	Program
1.0000	

Up or Down  arrow
key to change secondary
parameter Hi limit

1 Sec LoLim	Program
8.0000	

Right  arrow key to program
next parameter

or

PROGRAM key to exit Program
Mode and return to Ready mode.

2.3.13 Load Correction

Load correction allows the user to specify the value of the component under test (user supplied standard) and apply a correction to subsequent measurements of similar components under the same test conditions. This feature corrects for instrument non-linearity and for fixture effects which can be dependent on the test frequency, test voltage level or impedance range.

Measurement accuracy is 0.25 x (normal accuracy) with Load Correction implemented and compared to user supplied standard and for the same measurement conditions (test voltage, test frequency, and 1910 measurement range).

This increased accuracy applies in a range of:

DUT's with impedance (Z) between 3Ω and 800kΩ, with
programmed voltage from 100mV to 1V

Load correction can be set to **Off** or **On**. Off disables any load correction, On enables load correction with any currently stored values. Press **START** performs a measurement on a DUT to determine the load correction based on the primary and secondary nominal values previously entered. Refer to paragraph 2.3.10 and 2.3.12. After a correction measurement, load correction is turned on, and the values can be observed in Primary and Secondary Load Correction displays. Refer to paragraphs 2.3.14 and 2.3.15. With load correction turned On these corrections are applied to ongoing measurements and the final corrected value displayed.

Up or Down  arrow key
to change load correction

LoadCorrect (START=get) Off

LoadCorrect (START=get) On

Press **START** to determine load corrections from measurement of the DUT (based on primary and secondary nominal values)

Right  arrow key to
next parameter and observe load
corrections

or
PROGRAM key to exit Program
Mode and return to Ready mode.

1	Ls	-----	H
	Q	-----	

Typical display during
measurement

2.3.14 Primary Load Correction

The value shown is the measured load correction for the primary parameter, which can be further altered by the operator as shown below.

Primary Load Correction = Load Correction Measured minus the Primary Nominal value)

For example, if the load correction measured is 148.000 nH (para 2.3.13) and the primary nominal is 140.000 nH, the primary load correction shown here would be -8.0000 nH.

Up or Down  arrow key
to change load correction

1 Pri LoadCorr	Program
-8.0000 nH	

Right  arrow key to program
next parameter

or

PROGRAM key to exit Program
Mode and return to Ready mode.

2.3.15 Secondary Load Correction

The value shown is the measured load correction for the secondary parameter, which can be further altered by the operator as shown below.

Secondary Load Correction = Load Correction Measured minus the Secondary Nominal value)

For example, if the load correction measured is a Q of 10.5670 (para 2.3.13) and the secondary nominal is 10.0000, the secondary load correction shown here would be -0.5670.

Up or Down  arrow key
to change load correction

1 Sec LoadCorr	Program
-0.5670	

Right  arrow key or
PROGRAM key to exit Program
Mode and return to Ready mode.

2.4 Program/Sequence (Test S1-S9)

Sequence tests (S1 through S9) are selected by pressing **Up or Down** arrow key when instrument status is in the **Ready** or power up mode.

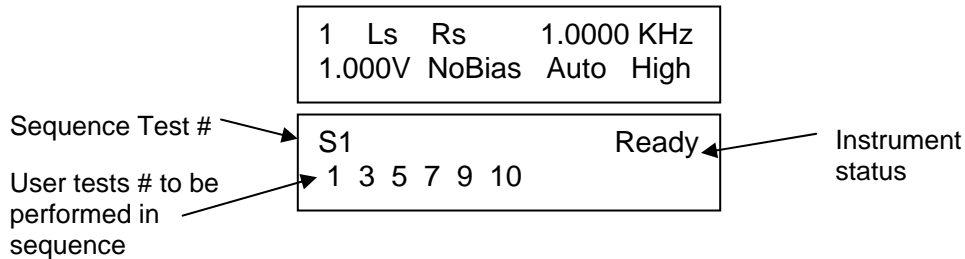

The above display is typical showing **S1** is the sequence test setup #, the sequence programmed to perform user tests **1,3,5,7,9,and 10** in succession, and **Ready** the instrument status. To select any other sequence test number simply press the **Up or Down** arrow keys while in the Ready state.

Programming A Sequence Test

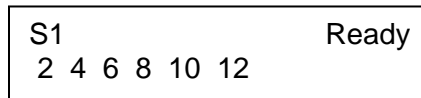

To enter programming mode
Press **PROGRAM**

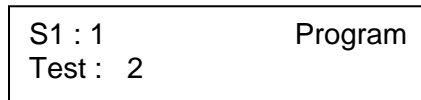

Sequence 1, Test 1

Up or Down  arrow key
to change test # for test 1

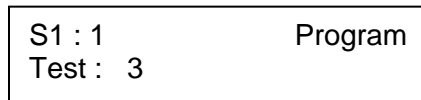

Tests 1 – 30, skip or none

Sequence 1, Test 2

Right  arrow key to select
test # 2 in the sequence



Up or Down  arrow key
to change test # for test 2

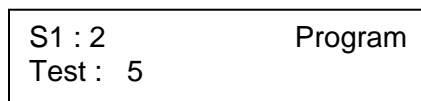

Tests 1 – 30, skip or none

Sequence 1, Test 3

Right  arrow key to select
test # 3 in the sequence

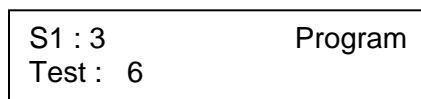

Up or Down  arrow key
To change test # for test 3



Tests 1 – 30, skip or none

Sequence 1, Test 4

Right ► arrow key to select test # 4 in the sequence

S1 : 4	Program
Test : 8	

Up or Down ▲▼ arrow key to change test # for test 4

S1 : 4	Program
Test : 9	

Tests 1 – 30, skip or none

Sequence 1, Test 5

Right ► arrow key to select test # 5 in the sequence

S1 : 5	Program
Test : 10	

Up or Down ▲▼ arrow key to change test # for test 5

S1 : 5	Program
Test : 11	

Tests 1 – 30, skip or none

Sequence 1, Test 6

Right ► arrow key to select test # 6 in the sequence

S1 : 6	Program
Test : 12	

Up or Down ▲▼ arrow key to change test # for test 6

S1 : 6	Program
Test : 13	

Tests 1 – 30, skip or none

PROGRAM key to exit Program Mode and return to Ready mode.

Binning Function During Sequence Tests

During a sequence test, each single step user test within the sequence (1 to 6) will be assigned to a bin according to the limits programmed for that single test, in other words, the bin assignment will be to bin 1 thru 14, the same as if the test was run as a single test. This is the bin assignment that will be shown when the results of a sequence is reviewed on the display (using the UP/DOWN arrow) or output remotely with a FETCH command. The bin assignment output through the Remote I/O output will be somewhat different. The bin outputs will not be asserted until all tests in a sequence have been completed, and the assignment will be bin 1 if all tests (1 to 6) pass or will be (N + 1), where N is the number of the first test that fails. One of these 7 bin outputs will always be asserted during a sequence test, even if all binning is turned Off, bin 1 is asserted as a Pass.

2.5 Utility Functions

The Utility functions allow the user to set instrument functions that affect all tests. When the **UTILITY** key is pressed the first function, Cal, and other functions (as list in Table 2-4) are accessed by pressing the **Right** ► arrow key. **BOLD** settings are the default settings.

Table 2-4
Programmable Parameters For Utility Functions

Programmable Functions	Settings
Cal with X M Cable	Cal Due: 1/ 1/2001 Quick Short Cal Quick Open Cal Quick Short/Open Cal Short Cal Open Cal Short/Open Cal Full Cal
Keypad Lockout	Lock Password, Off Lock Cycle Tests Passwd
Display Type	Measured Parameters Dev. from Nominal % Dev. from Nominal
Numeric Format	Engineering , Scientific
Trigger Source	Internal, External
Source Impedance	5Ω, 25Ω , 50Ω, 100Ω,
RS232 Baud Rate	9600 , 19200, 9600AutoReport 19200AutoReport, Disabled
IEEE-488 Address	1 to 16 (factory default set for 3)
Clear All Tests	No , Yes
Leveling	Off , On
Cable Compensation	No Cable 1 M Cable 2 M Cable
Freq. Edit Type	Discrete Continuous
Median	Single Meas. Median of 3
Distortion	Not tested Check during AC test
Serial Number	XXXXXXXX
Software Version	VX.XX

The Utility Function, factory shipped (default) conditions, are as follows:

Keypad Lockout:	Off	Clear All Tests:	No
Display Type:	Measured Parameters	Leveling:	Off
Numeric Format:	Engineering	Cable Compensation:	1M Cable
Trigger Source:	External	Frequency Edit Type:	Continuous
Source Impedance:	25 ohms	Median:	Single Meas
RS-232 Baud Rate:	9600	Distortion:	Not tested
IEEE-488 Address:	3		

2.5.1 Perform Calibration

This selection indicates the instruments expected calibration date and can be used to enter an open/short routine or to perform instrument calibration. The open/short (or zeroing process) automatically measures stray parameters and retains the data which are used to correct measurements so that the results represent parameters of the DUT alone without test lead or fixture effects. The cal routines, and when they should be used, are discussed in more detail below. The Quick cal routines can be performed much faster but are only applicable to the single test in which they are performed. Open/short data is deleted by going in and out of PROGRAM mode or programming any parameter of the current single test via remote. The operator is prompted by the 1910 display when performing the cal procedures.

Parameter Selections:

Quick Short Cal	Short zeroing at the currently programmed frequency only, used if measurements are to be low impedance.
Quick Open Cal	Open zeroing at the currently programmed frequency only, used if measurements are to be high impedance.
Quick Short/Open Cal	Both short and open zeroing at the currently programmed frequency only, used if measurements are to be over a wide range of impedance.
Short Cal	Short zeroing at all frequencies, used if measurements are to be low impedance.
Open Cal	Open zeroing at all frequencies, used if measurements are to be high impedance.
Short/Open Cal	Both short and open zeroing at all frequencies, used if measurements are to be over a wide range of impedance.
Full Cal	This procedure will alter the calibration of the instrument and should only be used by qualified calibration personnel (with password entry). The proper calibration equipment is required to perform this procedure, see the Service and Calibration section of this manual for addition information.

The example below performs a quick open/short, other routines are similar with user prompting displayed on the instrument display.

Right ► arrow key to skip Open/short and go to Keypad Lockout

Cal with 1 M Cable
Cal Due: 1/10/2001

Indicates due date of next annual calibration

or

Up or Down ▲▼ arrow key to select open/short calibration

Cal with 1 M Cable
Quick Short/Open Cal

Quick Short/Cal
Quick Open/Cal
Quick Short/Open Cal
Short Cal
Open Cal
Short/Op
Full Cal

“Quick Cal” is not a choice if test is a Sequence (S1 thru S9)
“Open Cal” and “Quick Open Cal” are not a choice if test is a DC test (DCR, DCV, DCI)

Right ► arrow key to start calibration. Connect Open

Connect OPEN standard.
Press START to continue.

Press **STOP** at anytime to exit Cal routine

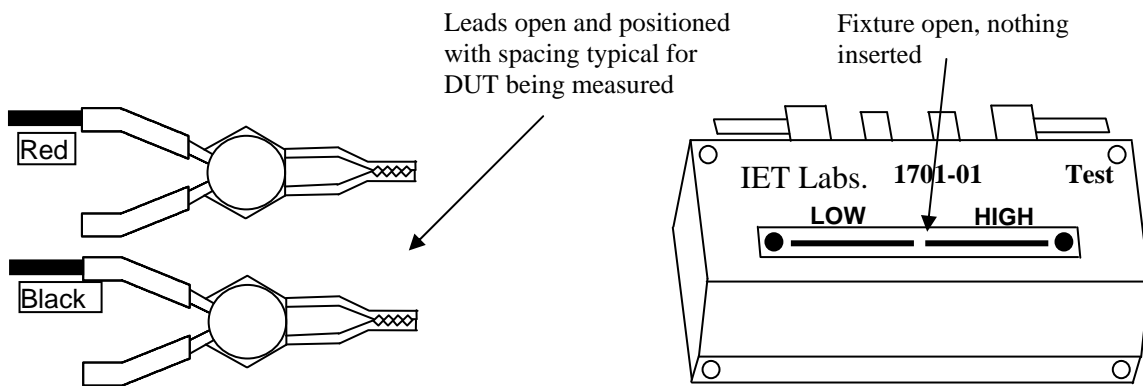
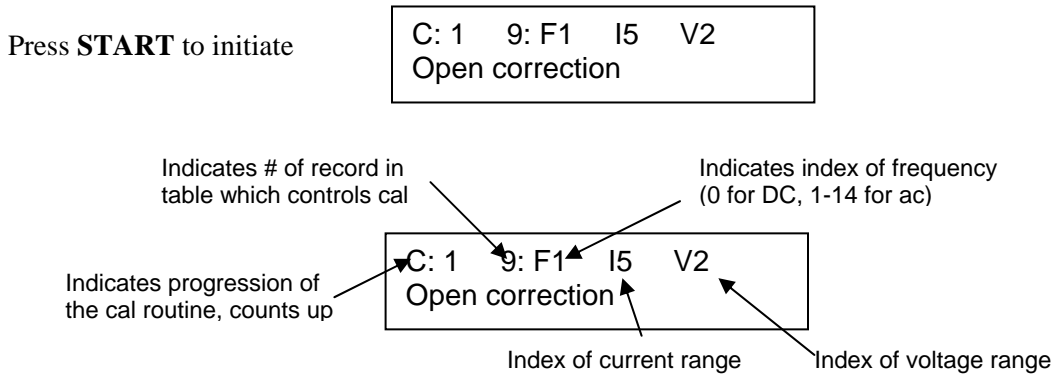

Figure 2-4
Open Circuit Configuration (Kelvin Clip Lead Set or Test Fixture)

Program the 1910 for **OPEN** as follows:



NOTE:
 During the open/short process these numbers should be changing.
 A flashing fail light during the open/short process indicates an error has occurred.

Remove Open, connect short

Connect **SHORT** standard.
 Press **START** to continue.

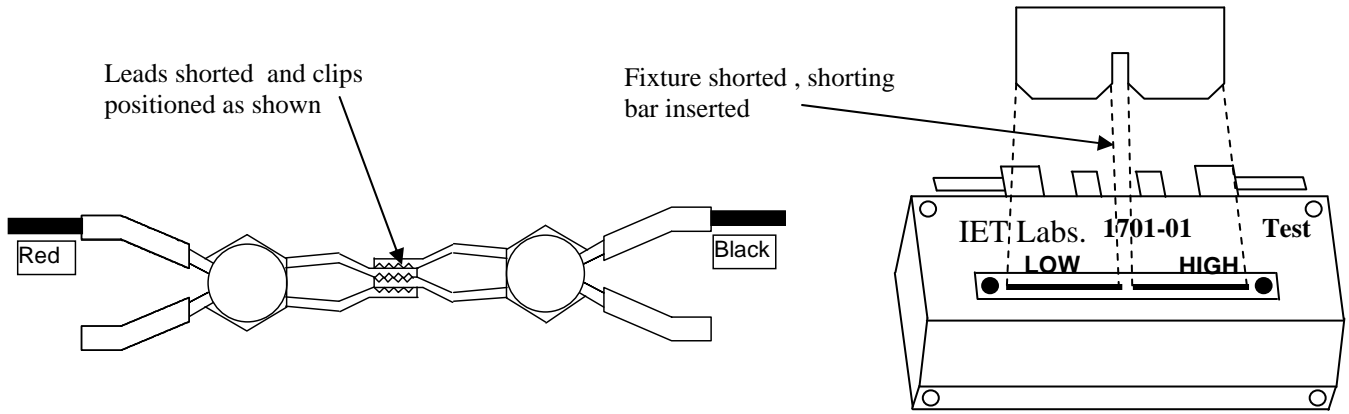

Figure 2-5
Short Circuit Configuration (Kelvin Clip Lead Set or Test Fixture)

Program the 1910 for **SHORT** as follows:

Press **START** to initiate
(DC Short Correction)

C: 1 9: F1 I5 V2
Short correction

Connect **SHORT** standard.
Press **START** to continue.

Press **START** to initiate
(AC Short Correction)

C: 1 9: F1 I5 V2
Short correction

Calibration Complete.
Press **START** to continue.

Press **START**, unit returns to
READY mode for testing
or

Press **UTILITY** key, then
Right ► arrow key to program
other Utility functions

1 Ls Rs 1.0000 KHz
1.000V NoBias Auto High

NOTE:

Quick short and open data are deleted by going in and out of **PROGRAM** mode or by programming any parameter of the current single test via remote.

The procedure for measuring the **OPEN** and **SHORT** corrections is optimized for fixtures and lead sets having a maximum uncompensated series impedance no greater than 50mΩ and a parallel (shunt) capacitance no greater than 5pF. If a **SHORT** calibration is performed with a fixture having higher uncompensated resistance, the applied voltage will be automatically reduced during the calibration to keep the voltage across the fixture within range. The **FAIL** light will be lit to indicate that this is happening. Similarly, the applied voltage will be reduced as necessary during an **OPEN** calibration to keep the current within range for each frequency/range combination. However, measurement accuracy will be degraded on some ranges if the uncompensated series impedance is greater than 250mΩ or the parallel capacitance is greater than 25pF.

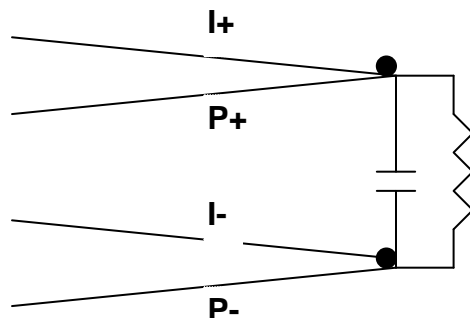

Uncompensated Series Impedance and Parallel Shunt Capacitance in a **SHORT** configuration

2.5.2 Keypad Lockout

Selection of **Off** allows the operator to modify any stored test conditions and use all functions of the instrument, with no restrictions. When a password is entered for **Lock Password** only, the currently selected test conditions, along with the instrument START and STOP functions are active. This prevents an operator from modifying test conditions. When a password is entered for **Lock Cycle Tests** the test number selection (1 thru 30) is active using the Up or Down arrow keys allowing selection of any of the stored setups, however none can be modified.

Passwords consist of 6 digits, where the Left or Right arrow key is used to select one of six digits and the Up and Down arrow key is used to increase or decrease the digit. In the event of an unintentional lockout the password override is 242671.

To Enable Lockout

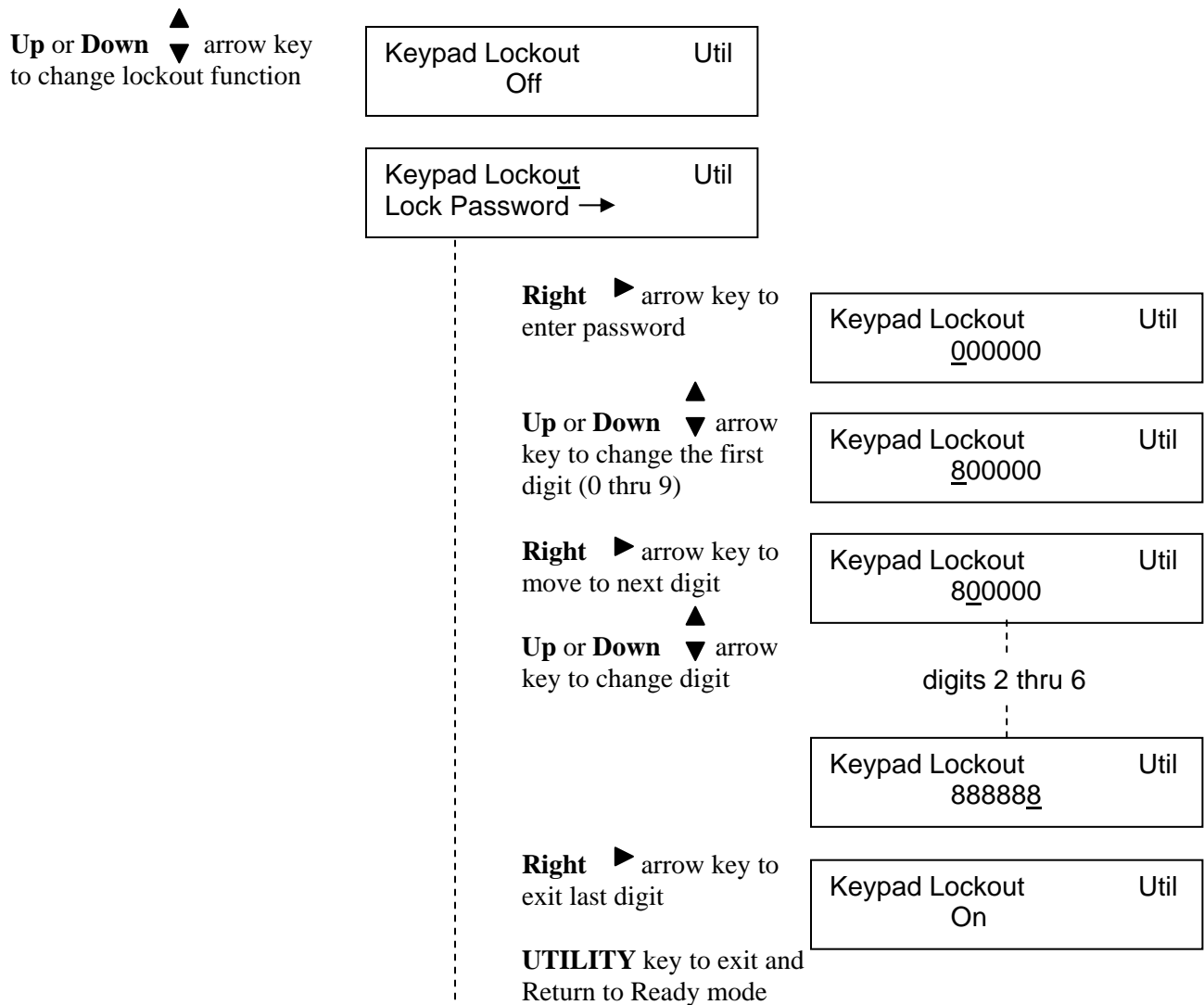

⋮

Keypad Lockout	Util
Lock Cycle Tests Passwd →	

Right ▶ arrow key to enter password

Keypad Lockout	Util
<u>0</u> 00000	

▲

Up or Down ▼ arrow key to change the first digit (0 thru 9)

Keypad Lockout	Util
<u>8</u> 00000	

Right ▶ arrow key to move to next digit

Keypad Lockout	Util
8 <u>0</u> 0000	

▲

Up or Down ▼ arrow key to change digit

⋮

digits 2 thru 6

Keypad Lockout	Util
8888 <u>8</u>	

Right ▶ arrow key to exit last digit

Keypad Lockout	Util
On With Test Number	

UTILITY key to exit and return to Ready mode.

To unlock Password

Press **Utility** key

Keypad Lockout On	Util
----------------------	------

OR

Keypad Lockout On With Test Number	Util
---------------------------------------	------

Up or Down  arrow key
to unlock password

Keypad Lockout Enter Password to Unlock	Util
--	------

Right  arrow key to
enter password

Keypad Lockout <u>0</u> 00000	Util
----------------------------------	------

Up or Down  arrow
key to change the first
digit (0 thru 9)

Keypad Lockout <u>8</u> 00000	Util
----------------------------------	------

Right  arrow key to
move to next digit

Keypad Lockout 8 <u>0</u> 0000	Util
-----------------------------------	------

Up or Down  arrow
key to change digit

Keypad Lockout 8888 <u>8</u>	Util
---------------------------------	------

digits 2 thru 6

Right  arrow key to
exit last digit

Keypad Lockout Off	Util
-----------------------	------

Right  arrow key to program
next Utility function
or

UTILITY key to exit and
return to Ready mode.

2.5.3 Display Type

Measured Parameters, Display is the measured values of both the primary and secondary, displayed with decimal point and units.

Deviation from Nominal, Display is the difference in measured value above or below (-) a programmed nominal value for the primary and secondary parameters. Refer to paragraph 2.3.10, programming the primary nominal and paragraph 2.3.12, programming the secondary display.

% Deviation from Nominal, Display is the measurement in terms of a percent difference above or below (-) a programmed nominal value for the primary and secondary parameters. Refer to paragraph 2.3.10, programming the primary nominal and paragraph 2.3.12, programming the secondary nominal.

Up or Down  arrow key
to change display type

Display Type	Util
Measured Parameters	

Display Type	Util
Dev. from Nominal	

Display Type	Util
% Dev. from Nominal	

Right  arrow key to program
next Utility function

or

UTILITY key to exit and
return to Ready mode.

Sample displays of measurement results are shown below for these three selections:

1	Ls	158.460	μH
Bin 1	Q	2.4890	

Measured Parameters

1	dev	Ls	158.460	μH
Bin 1	Q	2.4890		

Deviation from Nominal

1	%dev	Ls	1.10%
Bin 1	Q		-0.25%

% Deviation from Nominal

NOTE:

It should be noted that if the parameter names are ever displayed as lower case, i.e. ls instead of Ls and df instead of DF, etc., it implies that the instrument does not have the proper calibration data stored for the cable compensation length being used (1, 2 meters or no cable). To put this another way, the instrument is likely lacking some calibration data and is using “default” information rather than “real” calibration data.

2.5.4 Numeric Format

Allows selection from two different measurement results formats, **Scientific** or **Engineering** units. Scientific units are expressed as an exponent and engineering units are expressed in ohms for resistance, farads for capacitance, henries for inductance, etc. For example e^3 in scientific units can be expressed as $k\Omega$ in engineering units or e^{-3} in scientific units can be expressed as $m\Omega$ in engineering units, this is strictly user preference and convenience.

When scientific is selected the results will be displayed as some number of digits with decimal, exponent and units. When engineering units are selected the results will be displayed as some number of digits with decimal and units. The exception to this is that Q, DF, Phase and %, are always displayed as fixed point numbers.

Up or Down  arrow key
to change format type

Numeric Format	Util
Engineering	

Numeric Format	Util
Scientific	

Right  arrow key to program
next Utility function

or

UTILITY key to exit and
return to Ready mode.

Format example:

Engineering

1	Cs	6.5040	nf
Bin 1	DF	.000525	

Scientific

1	Cs	6.5040 e - 09	f
Bin 1	DF	5.2545 e - 04	

2.5.5 Trigger Source

This function allows the operator to select the measurement trigger mode between **Internal** or **External**. With trigger set for internal, once a start command is initiated (from front panel or remotely) the measurements will be repetitive and continually updated until a stop command is initiated. With trigger set for external a single measurement will be made once a start command is initiated (from front panel or remotely).

Up or Down  arrow key
to change trigger source

Trigger Source	Util
Internal	

Trigger Source	Util
External	

Right  arrow key to program
next Utility function
or

UTILITY key to exit and
return to Ready mode.

2.5.6 Source Impedance

This function allows the operator to select the 1910's output source impedance, selections available are **5, 25, 50, and 100Ω**. In general the measuring instrument's source impedance will usually have a direct effect on the measured impedance of the device. This is especially important when measuring the Q of a device and comparing the results between two different testers; in a true comparison the source impedance of the measuring instruments would be expected to be the same.

Up or Down  arrow key
to change source impedance

Source Impedance	Util
5Ω	

5Ω, 25Ω, 50Ω or 100Ω

Source Impedance	Util
100Ω	

Right  arrow key to program
next Utility function
or

UTILITY key to exit and
return to Ready mode.

2.5.7 RS-232 Baud Rate

This function allows the operator to select the baud rate when communicating via the RS-232 interface, selections possible include 9600, 19200, 9600 AutoReport, 19200 AutoReport or Disabled. The Auto Report options are used to log test results and error messages on a receive-only serial device, such as a serial printer. When set to Disabled the I/O port is non-functional, and the IEEE-488 port is functional.

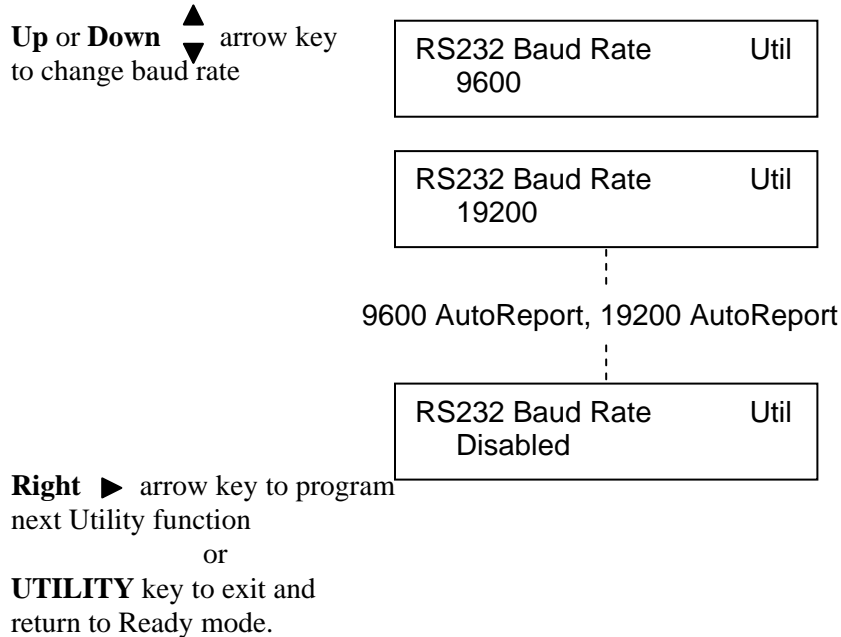

2.5.8 IEEE-488 Address

This function allows the operator to select the IEEE-488 address, selections possible are 1 thru 16. The RS-232 interface must be set to Disable for the IEEE-488 interface to function.

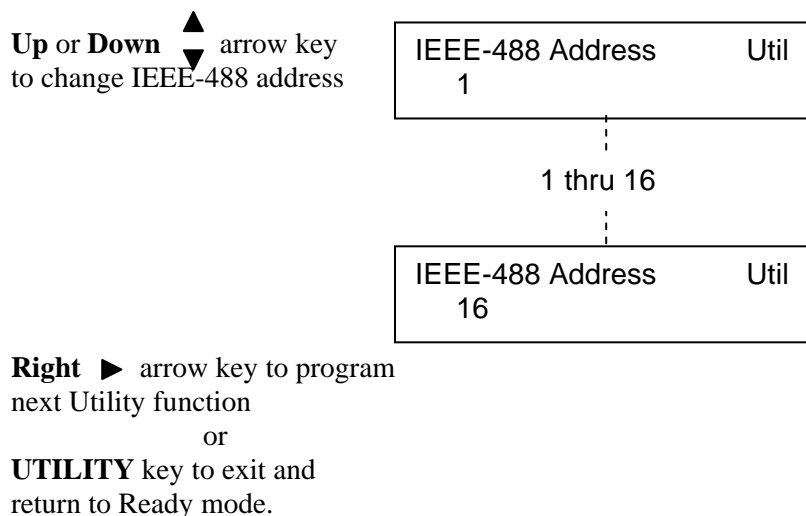

2.5.9 Clear All Tests

This selection allows the operator to clear all stored test setups in instrument memory (1 thru 30 for single tests or S1 thru S10 for sequential tests). After this operation, all tests are programmed to defaults coded by instrument software, which is generally as follows:

Primary:	Ls	Range:	Automatic
Secondary:	Rs	Delay:	0
Frequency:	1kHz	No to Average:	1
Amplitude:	1V	Bin Type:	OFF
Accuracy:	High	Load Corr:	OFF

Up or Down  arrow key
to select clear all tests

Clear All Tests	Util
No	

Clear All Tests	Util
Yes	

Right  arrow key to program
next Utility function

or

UTILITY key to exit and
return to Ready mode.

2.5.10 Leveling

This function provides a constant voltage mode where the DUT is measured at an AC test voltage as determined by the programmable test parameter, Amplitude (refer to paragraph 2.3.4) When leveling is set for On, the instrument will adjust its output voltage to make the voltage across the DUT equal to the programmed test voltage. This will not be possible in all cases because the source impedance and DUT impedance form a voltage divider.

Up or Down  arrow key
to change leveling

Leveling	Util
Off	

Leveling	Util
On	

Right  arrow key to program
next Utility function

or

UTILITY key to exit and
return to Ready mode.

2.5.11 Cable Comp.

This function allows the operator to select the type connection made to the device under test, a direct connection to the front panel, **No Cable**, **1 M Cable** or **2 M Cable**. The 1910 is factory calibrated to compensate for the various lengths of test cables, choosing the correct cable length is important to assure accurate measurements. In addition to this, an open short circuit should be conducted any time the cable length is changed, refer to paragraph 2.5.1.

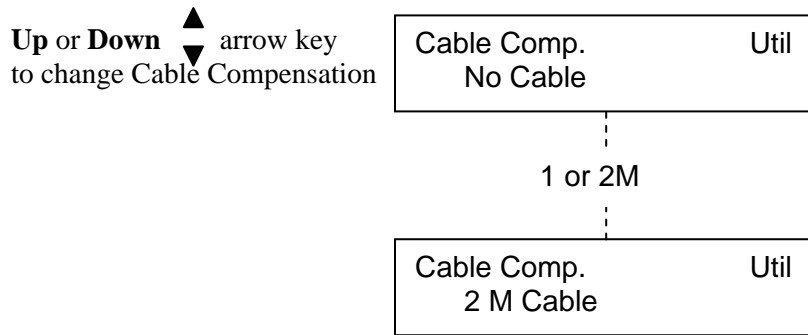

Right ► arrow key to program
next Utility function
or
UTILITY key to exit and
return to Ready mode.

2.5.12 Freq. Edit Type

This function allows the operator to choose the test frequencies that will be available for selection, (refer to paragraph 2.3.3). **Discrete**, giving 16 possible frequencies and **Continuous** covering the entire frequency range from 20 Hz to 1 MHz.

When discrete is selected the 16 possible frequencies are:
20, 50, 100, 200, 400, 500 Hz, 1, 2, 5, 10, 20, 50, 100, 200, 500 kHz, and 1 MHz

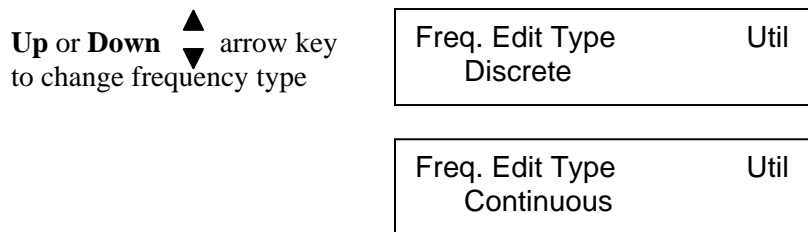

Right ► arrow key to program
next Utility function
or
UTILITY key to exit and
return to Ready mode.

2.5.13 Median

This function allows the operator to choose single or median measurement mode. When median of 3 is selected three individual measurements are made, the lowest and highest values are discarded and the median value displayed. Median mode can improve instrument accuracy by: specified accuracy/divided by $\sqrt{3}$; but never less than 0.1%.

Up or Down  arrow key
to change median

Median Single Meas.	Util
------------------------	------

Median Median of 3	Util
-----------------------	------

Right  arrow key to program
next Utility function

or

UTILITY key to exit and
return to Ready mode.

2.5.14 Distortion

This function allows the operator to choose a distortion check during ac testing. When set to **Check during AC test**, the unit will detect distortion during a measurement and indicates the message "Signal Distorted" if this condition occurs. When set to **Not tested**, distortion will not be detected during a measurement.

Distortion is dependent on programmed test conditions, connection to the device, device impedance and is indicated when the current or voltage on the DUT at frequencies other than the test frequency is more than 2% of the signal at the test frequency. Distortion checking is generally the recommended test condition and is particularly important for high precision measurements where test leads could resonate with the device under test. Distortion may be best unchecked in a "noisy" environment or if the test voltage is below 100mV.

Up or Down  arrow key
to change distortion

Distortion Not tested	Util
--------------------------	------

Distortion Check during AC test	Util
------------------------------------	------

Right  arrow key to program
next Utility function

or

UTILITY key to exit and
return to Ready mode.

2.5.15 Serial Number

This function allows the operator to view the instrument serial number. This serial number can also be returned when the unit is under remote control but there is no command for changing this number.

Serial Number 0104985

UTILITY key to exit and return to Ready mode.

2.5.16 Software Version

This function allows the operator to view version of software installed in the instrument.

Software Version V1.32

UTILITY key to exit and return to Ready mode.

2.6 Error Messages

Operator Help messages

Error in calibration
Watchdog timeout Consult factory
Measurement timed out Consult factory
Test voltage out of range; check for short
Calibration incomplete, Stopped by user
Out of range parameter value rcvd from remote
Invalid command received from the remote
Only the arrow keys are valid
Only the arrow and utility keys are valid
Only the arrow and program keys are valid
Invalid test set to default
Only the up and down arrow keys are valid
Only the start and stop keys are valid
Only up, down, and right arrow keys are valid
Only up, down, start and test keys are valid
Quick short/open valid only for single test
DSP appears busy. Press STOP to clear
DSP did not take enough samples

Operator Help messages (continued)

Test is disabled program sequence test
DSP reported invalid params; check setup
Frequency and locked range incompatible
Locked range invalid for AC; set to HOLD
Primary nominal invalid Set to default
Secondary nominal invalid; set to default
Load correction invalid, for AUTO meas: disabled
Bin limits reset to defaults
Test restored from defaults correctly
Eeprom calibration defaults being set
Saving cal coefficients. Please wait
IEEE488 hardware not detected
Eeprom test/step data defaults being set
Eeprom misc data defaults being set
Eeprom cal kit data defaults being set
Eeprom lockout state default being set
Calibration measurement failed
Invalid calibration code
Cal kit data invalid. Please re-enter
Invalid cal state Contact factory
Invalid prog state Contact factory
Current bias invalid Compliance V exceeded
Current bias invalid Current source shutdown
Signal distorted: DUT is nonlinear
A/D current input ovrng
A/D voltage input ovrng
Unable to level applied voltage

Instrument Error Messages

FATAL UNABLE TO WRITE, EEPROM CURRENT TEST/STEP
FATAL EEPROM CAL DATA, CANNOT BE INITIALIZED
FATAL EEPROM TEST DATA, CANNOT BE INITIALIZED
FATAL EEPROM MISC DATA, CANNOT BE INITIALIZED
EEPROM MISC CAL DATA, CANNOT BE INITIALIZED
FATAL INVALID MEAS, STATE HANDLER RETURN
DSP/HOST CODE MISMATCH, NEEDS DSP VERSION
FIRMWARE CRC ERROR, CONSULT FACTORY
FATEAL UNABLE TO WRITE, CALIBRATION DATA
GENERAL INTERNAL ERROR, CONSULT FACTORY

Section 3: Interface

3.1 General

The 1910 Inductance Analyzer includes three interfaces standard with the unit, the Remote I/O , RS-232 and IEEE-488. Connection for these are located on the instrument's rear panel and discussed in detail below.

3.2 Remote I/O

The 1910 comes standard with an automatic component remote I/O interface port available through a 37 pin DB type connector located on the rear panel of the instrument. This port outputs signals to indicate a measurement in process and bin sorting judgements. It also has inputs for an external start and stop. All output lines are negative true from open-collector drivers that pull each signal line to a low voltage when that signal is active and let float when inactive. Each external line must be powered by a positive voltage between 5 and 24V (max), with sufficient impedance (pull-up resistors implemented externally) to limit the active-signal (logic low) current to 20mA (max).

The input signals are also active low and also requires a positive external voltage which must pull the signal down below 0.4V (but not negative). For the inactive state (logic high), the external circuit must allow the signal line with its internal 3.3kohms to float above +2.5V, but not above 5V.

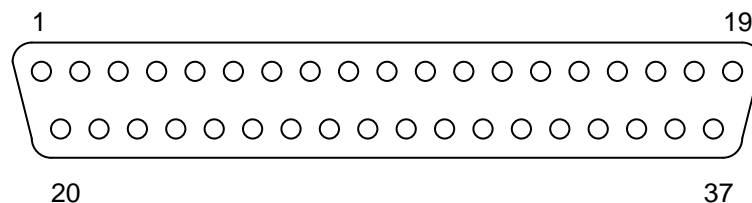

Figure 3-1
RS232 Remote I/O Pin Configuration

**Table 3-1
Remote I/O Interface Connections**

Signal Name	Pin Number	Function
Outputs:		
Busy	1	Measurement in process
Bin 1	2	Primary Pass or Secondary Pass if binning is enabled and all Primary bin limits are set to Off or All steps in a Sequence test are Pass
Bin 2	3	Primary Pass or step 1 in a Sequence test Fails
Bin 3	4	Primary Pass or step 2 in a Sequence test Fails
Bin 4	5	Primary Pass or step 3 in a Sequence test Fails
Bin 5	6	Primary Pass or step 4 in a Sequence test Fails
Bin 6	7	Primary Pass or step 5 in a Sequence test Fails
Bin 7	8	Primary Pass or step 6 in a Sequence test Fails
Bin 8	9	Primary Pass
Bin 9	10	Primary Pass
Bin 10	11	Primary Pass
Bin 11	12	Primary Pass, Secondary Fail Low
Bin 12	13	Primary Pass, Secondary Fail High
Bin 13	14	Primary Fail, Secondary Pass
Bin 14	15	Primary Fail, Secondary Fail
EOT	16	End of Test, goes low at end of measurement
Gnd	20 – 35	Signal ground
Inputs:		
Start	17	Starts the measurement
Stop	18	Stops the measurement in process

3.3 RS-232 Interface

An RS232 serial port interface is available on the 1910 through a 9 pin DIN connector on the rear panel of the instrument. The RS232 standard defines electrical specifications for the transmission of bit serial information. The use of the RS232 port requires three lines, receive data, transmit data, and signal ground. Refer to Figure 3-3 for null modem cable configuration to the standard db9 or db25 connector. Refer to Table 3-4 for the command set which also applies to the RS232 interface. Each command line must be terminated with a carriage return (CR) and line feed (LF) and multiple commands separated by a semicolon. Baud rate for the RS-232 interface is programmed through the UTILITY menu, refer to paragraph 2.5.7. Serial port parameters are comprised of 8 data bits, 1 stop bit, and no parity.

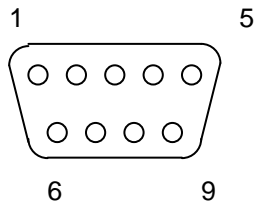

Figure 3-2
RS232 Interface Pin Configuration

Table 3-2
RS232 Interface Connections

Signal Name	Pin Number	Function
Inputs:		
DCD	1	Data Carrier Detect
DSR	6	Data Set Ready
RXD	2	Receive Data
CTS	8	Clear to Send
RI	9	Ring Indicator
Outputs:		
RTS	7	Request to Send
TXD	3	Transmit Data
DTR	4	Data Terminal Ready
GND	5	Signal Ground

db9 to db9 Cable Configuration

1910			Controller	
Pin #	Function		Pin #	Function
2	Receive data	Connect to	3	Transmit data
3	Transmit data		2	Receive data
4	Data terminal ready		6	Data set ready
5	Signal ground		5	Signal ground
6	Data set ready		4	Data terminal ready

db9 to db25 Cable Configuration

1910			Controller	
Pin #	Function		Pin #	Function
2	Receive data	Connect to	2	Transmit data
3	Transmit data		3	Receive data
4	Data terminal ready		6	Data set ready
5	Signal ground		7	Signal ground
6	Data set ready		20	Data terminal ready

Figure 3-3
RS-232 Cable Configurations

3.4 IEEE-488.2 Interface

3.4.1 General

An IEEE-488 interface is available standard on the 1910 through a connector (24 pin) on the rear panel. This interface can be used to connect to a system containing a number of instruments and a controller in which each meets IEEE Standard 488.2 (Standard Digital Interface for Programmable Instrumentation) Refer to Table 3-3 below for a full tabulation of connections and Table 3-4 for the command set.

The following functions have been implemented. Refer to the standard for an explanation of the function subsets, represented by the identifications below.

SH1	Source Handshake	PP1	Parallel Poll
AH1	Acceptor Handshake	DC1	Device Clear
T5	Talker	DT1	Device Trigger
L3	Listener	C0	Controller
SR1	Service Request	E2	Electrical Interface
RL1	Remote Local		

3.4.2 IEEE-488 Connections

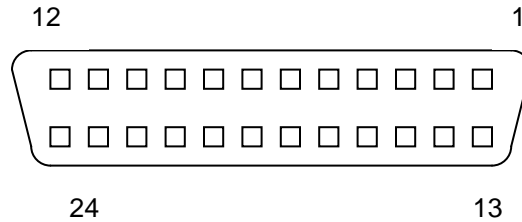

Figure 3-3
IEEE-488 Interface Pin Configuration

Table 3-3
IEEE-488 Interface Connections

Signal Name	Pin Number	Function
DAV	6	Low state: "Data is Available" and valid on DI01 through DI08
NRFD	7	Low state: At least one listener on the bus is "Not ready for Data".
NDAC	8	Low state: At least one listener on the bus is "Not Accepting Data".
ATN	11	"Attention" specifies 1 of 2 uses for the DI01 through DI08 lines Low state - Controller command messages High state - Data bytes from the talker device
IFC	9	"Interface Clear" Low state - Returns portions of interface system to a known quiescent state.
SRQ	10	"Service Request" Low state - a talker or listener signals (to the controller) need for attention in the midst of the current sequence of events
REN	17	"Remote Enable" Low state - enables each device to enter remote mode when addressed to listen High state - all devices revert to local control
EOI	5	"End of Identify" if ATN is in high state, then low state of EOI indicates end of a multiple-byte data transfer sequence. If ATN is in low state, then low state of EOI activates a parallel poll.
DI01	1	The 8-line data bus, which conveys interface messages (ATN low state) or device-dependent
DI02	2	

**Table 3-3 (Continued)
IEEE-488 Interface Connections**

Signal Name	Pin Number	Function
DI03	3	messages (ATN high state), such as remote-control commands from the controller or from a talker device
DI04	4	
DI05	13	
DI06	14	
DI07	15	
DI08	16	

3.4.3 IEEE-488 and RS-232 Commands

NOTE:
Refer to: <http://www.IET Labs.com> for the latest sample programs that may be available.

**Table 3-4
IEEE & RS-232 Commands**

Command	Function	Parameter(s)
<u>SAVE SAVE</u>	Save changes entered by remote since power-up.	

NOTE:
Command must be entered twice. If not done, changes will be lost on power cycle.

TEST:

TEST	Set test number	nn
STEP	Set step number	n
SEQuence	Set sequence test number	n

NOTE:

CONFigure or SYSTem commands that follow should only be used with the commands for which they were intended. The 1910 commands are interpreted as numeric values but for convenience in programming they are not entered as numeric but rather as a more understandable command. For example; when programming the primary parameter for Lp it would appear as “CONF: PPAR LP”, which is also equivalent to “CONF: PPAR 2”. It is possible to create a command that appears wrong but will not generate any error message. If the command was “CONF: PPAR DPCT”, the primary parameter would still be Lp because DPCT is interpreted as a numeric value of 2, even though it’s a subset of an entirely different command (subset of DISPlay). To eliminate any confusion always use the subset commands in conjunction with those listed in this table.

**Table 3-4 (Continued)
IEEE & RS-232 Commands**

Command	Function	Parameter(s)
CONFigure:		
PPARAmeter	Set primary parameter	AUTO LS LP RS RP CS CP DF Q Z Y P ESR GP XS BP V I DCV DCR DCI
SPARAmeter	Set secondary parameter	NONE LS LP RS RP CS CP DF Q Z Y P ESR GP XS BP V I DCV DCR DCI
FREQuency	Set test frequency in Hz	nnn
APPLV	Set test voltage in V (rms if AC)	n.nnn
BIAS	Set bias current in A	n.nnn
RANGE	Select range	AUTO HOLD nn
MAC	Set measurement accuracy	LOW MEDIUM HIGH LND

NOTE:

When programmed for Low No Display (LND), measurement data is not available via IEEE-488 or RS-232 interfaces, but only available as binning data through the Remote I/O interface

TDElay	Set delay time in S	nnn.n
AVERAge	Set count to average	nnn
PNOMinal	Set the nominal value of primary meas	MEAS n.nnn
BINning	Set binning type	NONE PCTdev ABSolute
HIGH	Set high limit in mA	nn.nnn
PHIDEV	Set primary bin## high limit to n.nnn	## n.nn
PLODEV	Set primary bin## low limit to n.nnn	## n.nn
SNOMinal	Set nominal value of secondary meas	n.nnn
SHIDEV	Set secondary parameter high limit	n.nnn
SLODEV	Set secondary parameter low limit	n.nnn
LOADcorr	Set load correction	OFF ON MEAS
PLOAD	Set primary load correction	n.nnn
SLOAD	Set secondary load correction	n.nnn

**Table 3-4 (Continued)
IEEE & RS-232 Commands**

Command	Function	Parameter(s)
<u>SEquence:</u>		
TEST	Set current step to test number	nn NONE SKIP
<u>SYSTEM:</u>		
LOCKout	Lockout keypad from the remote	OFF ON
DISPlay	Set display type	DMEAS DDEV DPCT
FRESult	Format result type	SCI ENG
TRIGger	Trigger type	EXT INT
SRCImp	Set source impedance	n(0-3)
LEVELing	Set voltage leveling	OFF ON
CABLEcomp	Set cable compensation	n(0-3)
DISCrete	Allows continuous frequencies	OFF(discrete) ON (cont)
DISTortion	Enable test for distorted AC	OFF ON
MEDIAN	All measurements use median of 3 tries	OFF ON
CALibrate	Invoke calibration	FULL SHORT OPEN QUICKos
DATE	Set calibration date	nn nn nnnn
<u>VIEW:</u>		
<u>TEST?:</u>	View the test program parameters	
TEST	View the single-test's parameters	nn
SEquence	View the sequence	n
The format of the returned data is as follows:		
Step 1: Test<tab.nn or Fn or skip or none><CR>		
Step 2: Test<tab.nn or Fn or skip or none><CR>		
Continued through Step 6		
<u>UTILity?</u>	View the utilities programmed	
<u>LOCKout?</u>	View the lockout state	
<u>DATA?</u>	Returns the non frequency dependent calibration data	
<u>DATA?N</u>	Returns the frequency dependent calibration data for cal frequency N	
<u>DCALibration?</u>	Returns calibration date	
<u>CAL</u>	Refer to paragaraph 3.4.4, Remote Calibration	
<u>STOP</u>	Stops a measurement	

Table 3-4 (Continued)
IEEE & RS-232 Commands

Command	Function	Parameter(s)
<u>MEASure</u>	Triggers a measurement of the selected type. If sequence is enabled this command will trigger those type of measurements also. The result type is set by the display type parameter	
<u>M?</u>	Triggers a measurement of the selected type, and automatically returns the answer after the measurement is complete. This command is a faster way to implement the sequence “MEAS; *WAIT; FETCH?”. If sequence is enabled this command will trigger those type of measurements also. The result type is set by the display type utility (and by the measurement ACCURACY setting, if LOW NO DISPLAY is selected.)	
<u>FETCh?</u>	<p>Fetches the most recent measurement results. The reply is a copy of the LCD screen, with the following exceptions:</p> <p style="padding-left: 40px;">The ohms, degrees, and micro symbols are replaced by “ohm”, “deg”, or “u”</p> <p>Each group of one or more spaces is replaced with one tab character (ASCII 9)</p> <p>Each line of the display is followed by CRLF</p> <p>For a sequence test, the results of each test which has been performed are reported</p> <p>If TRIGGER is set for INTERNAL the results of the last measurement are reported. For a sequence test, results from the later steps in the sequence may have been measured on the previous pass through the sequence</p> <p>When accuracy is selected to LOW, NO DISPLAY, there is no choice of display format, and the data will be returned as follows:</p>	

**Table 3-4(Continued)
IEEE & RS-232 Commands**

Command	Function	Parameter(s)
	<p>If the secondary parameter is set to NONE, the format will be: n.nnnnEmmm<space>*<space></p> <p>If the secondary parameters is set to anything other than NONE, the format will be: n.nnnnEmmm<space> n.nnnnEmmm <space></p> <p>If the measurement is invalid for some reason (typically an A/D overrange, because normally the range will be locked to shorten the cycle time), the return format will be: No<tab>Data</p>	
<u>ERRMSG?</u>	<p>When error messages are presented on the front panel, they are also logged in a 16-deep queue, and the device-dependent error bit is set in the ESR. The response to this query consists of the text of each error message in the log, with each line followed by <CRLF>, and an additional <CRLF> after the last message. The queue is cleared by sending ERRMSG?, *RST, or *CLS.</p>	
<u>SUMMARY?</u>	<p><u>When test is a single step test</u> Read bin summary. If bin is enabled format will be: nn<tab>h.hhhehh<tab>l.llell<tab>cccc<CRLF></p> <p>Where nn is the bin number, h and l are digits of the high and low limits, and c the digits of the bin count (primary units for bins 1-10 and secondary units for bin 11). Numeric limits for bins 12-14 will always return 0, since these bins do not have independent limits</p> <p>If bin is disabled format will be: nn<tab>Disabled<tab><tab></p> <p>If all primary bins are disabled, Bin 1 is used to count devices which pass secondary limits and will be returned as: 1<tab>Both Pass<tab><tab>cccc</p> <p><u>When test is a sequence test, format will be</u> 1<tab>PassAllSteps<tab><tab>cccc nn<tab>FailStepm<tab><tab>cccc</p> <p>Where nn is bin numbers 2 through 7 and m is the corresponding test number, which is (nn-1).</p>	

Table 3-4 (Continued)
IEEE & RS-232 Commands

Command	Function	Parameter(s)
----------------	-----------------	---------------------

<p>NOTE: Bin limits are always returned as absolute deviation even if bin type is % deviation. This is a convenient way to see what the actual limits will be when setting up a test</p>

<u>*IDN?</u>	Returns instrument identification "IET Labs Inc., 1910,xx...xx, software version". x denotes serial number up to 8 digits	
<u>*ESR?</u>	Returns the read of the event status register.	
<u>*STB?</u>	Returns the read of the status byte register.	
<u>*ESE?</u>	Returns the read of the event status enable register.	
<u>*SRE?</u>	Returns the read of the service request enable register.	
<u>*ESE</u>	Set the event status enable register	value
<u>*SRE</u>	Set the service request enable register.	value
<u>*RST</u>	Reset the common buffers	
<u>*TST</u>	Self test query	
<u>*CLS</u>	Clear standard event status register	
<u>*OPC</u>	Operation complete	
<u>*OPC?</u>	Is operation complete	
<u>*WAIT</u>	Wait until operation is complete before executing next command	

3.4.4 Remote Calibration

Calibration can also be controlled from a remote terminal (RS-232 or IEEE-488). The LCD display is also active, but the prompts returned to the terminal use different wording.

The unit must be in LOCAL LOCKOUT state (the light below the remote light will be lit).

If the host terminal is RS-232, prompts are sent by the 1910 with no action by the host. The URQ bit in the ESR is used to signal to an IEEE-488 host that a prompt is available. This bit may be monitored by polling ESR, or the SRQ mechanism may be used to retrieve prompts. Refer to your IEEE-488 documentation for details on enabling the SRQ.

Before starting a remote FULL calibration, the reference data for the cal kit must be stored in the instrument. These data are used to calculate the reference values for all transimpedance measurements. Use the STANDard command (described below) to enter the reference data for the cal kit which will be used. These data are stored in nonvolatile memory and it is not necessary to enter them again unless another cal kit is to be used.

They are the last values returned in response to a DATA? query.

There is only one set of cal kit values. However, there are three copies of the entire set of calibration coefficients, corresponding to the three cable compensation choices available in the UTILITY menu. This utility setting determines which set of coefficients will be modified by the calibration.

Command: STANDARD

Short version: STAN

Syntax STANDARD <ROI><Value>

where <ROI> is a single floating point number in which the 100s digit is the 1-based index of the resistor to edit (1 = 5 ohm, 5 = 95K), the 10s digit is the "option", as follows:

- 0 Edit count of data points for this resistor, legal values are 2, 3, 4
- 1 Edit frequency
- 2 Edit R value
- 3 Edit Q value (in ppm)

and the 1s digit is the 1-based index of the record to edit,
allowed values 1 thru 4 (not used when option is 0 but still must be a number 1-4).
All 4 records can be edited for each resistor even if the "count" for that resistor is set to 2 or 3.

Examples: ROI Value

STANDARD	101	3	means 5 ohm resistor will use the first 3 data points
STANDARD	212	1.0e3	means the Frequency for the 2nd record describing the 25 ohm resistor is 1KHz
STANDARD	222	24.999	means the R value for the same record is 24.999
STANDARD	232	100	means the Q is 100 ppm for the same record

The URQ (0x40 or decimal 64) bit in the ESR may be used for handshaking. Enable it by setting this bit in the ESE register:

*ESE 64

In order to perform a remote calibration, the local keys must be locked out with the command
SYST: LOCK ON

Four types of calibration may then be selected:

CAL FULL
CAL OPEN
CAL SHORT
CAL QUICK

If a FULL calibration is being performed, set the date using the DATE command.

CAL DATE MM DD YYYY

The front panel display will remain active and prompts relating to the calibration may be read from the display or read over the remote. When a new prompt is presented on the front panel, the URQ bit will be set; the ESR can be polled to detect this bit. The prompt must be read to clear this bit:

CAL FETCH?

Returns the prompt. The text of the prompt will indicate what action the user needs to take, if any. The second part of the string indicates what handshake is expected to allow the calibration to continue. If it reads,

"; send CAL MEAS to continue."

Perform the action requested by the first part of the string and then send CAL MEAS. If the second part of the prompt is of the form

": Min n.nnn Max m.mmm"

make the requested measurement and enter the value (which will be a voltage measurement); if the measurement is not in the specified range, something is wrong. The command in this case is of the form

CAL n.nnn

No units are sent, and the value must be in fixed point format.

If a serious mistake is made when connecting a DUT (such as leaving the fixture OPEN after being prompted for a SHORT), the calibration MAY fail due to an A/D overload. If the message "A/D current input ovrng" is displayed or returned as a prompt, the calibration must be aborted by sending STOP. There is no way to back up and continue from the last successful part of the calibration; it must be restarted from the beginning.

NOTE:

The 19xx calibration procedure is designed to allow calibration with a wide range of cables and fixtures. There is no specification for how big a mistake is required to cause the calibration to fail. If the FAIL light on the front panel flashes during calibration, the setup should be rechecked and the calibration repeated.

When a calibration completes normally, the new data are automatically saved to nonvolatile memory. It is not necessary to send the SAVE:SAVE sequence to cause them to be updated. If the cal kit data are updated during the calibration, the new values will be saved only after a successful calibration. If the cal kit data are updated at any other time, it is necessary to send SAVE:SAVE to cause them to be written to nonvolatile memory.

Unlock the front panel by sending

SYST: LOCK OFF

The prompts for a full calibration are as follows:

Connect VCal box, SW=OFF; send CAL MEAS to continue.
Enter RMS volts:: Min 0.200000 Max 2.000000
Enter RMS volts:: Min 0.020000 Max 0.200000
Set VCal box switch ON.; send CAL MEAS to continue.
Enter RMS Volts:: Min 0.200000 Max 0.800000
Set VCal box switch OFF.; send CAL MEAS to continue.
Enter DC volts:: Min 0.200000 Max 2.000000
Enter negative DC volts:: Min 0.200000 Max 2.000000
Enter DC volts:: Min 0.005000 Max 0.025000
Enter negative DC volts:: Min 0.005000 Max 0.025000
Set VCal box switch ON.; send CAL MEAS to continue.
Enter DC Volts:: Min 0.200000 Max 0.800000
Enter DC Volts:: Min 0.100000 Max 1.000000
Connect OPEN standard.; send CAL MEAS to continue.
Connect SHORT standard.; send CAL MEAS to continue.
Connect SHORT standard.; send CAL MEAS to continue.
Connect 5.0ohm standard.; send CAL MEAS to continue.
Connect 25ohm standard.; send CAL MEAS to continue.
Connect 374ohm standard.; send CAL MEAS to continue.
Connect 5.9Kohm standard.; send CAL MEAS to continue.
Connect 95Kohm standard.; send CAL MEAS to continue.
Calibration complete.; send CAL MEAS to continue.
meas: lock off

3.4.5 Formats

IEEE 488.2 enable remote programming of all instrument functions, measurement conditions and comparator settings etc. Outputs include measurement conditions, open corrections, and measured values.

Data Formats

Data will be transmitted in ASCII NR3 format per IEEE488.2 sec. 8.7.4 and reproduced below.

Multiple results

All response messages will be terminated by the NL character together with the EOI line asserted.

Status Byte Register

<u>Bit</u>	<u>Decimal Value</u>	<u>Use</u>
7	128	Measure completed
6	64	SRQ, SPOL Resets
5	32	Summary of Standard Event Status Register*
4	16	Message Available
3	8	Pass
2	4	None
1	2	None
0	1	None

*The Status Byte Register is readable via the standard *STB? as defined in paragraph. 11.2.2.2 of the IEEE spec. The 1910 will also implement an SRE register to enable each bit of the Status Byte Register per paragraph 11.3.2 of the IEEE spec. This register shall be readable by a SRE? command and writeable by a SRE <#> command.

Standard Event Status Register

<u>Bit</u>	<u>Decimal Value</u>	<u>Use</u>
7	128	Power Up Since Last Query
6	64	None
5	32	Command Error (Syntax)
4	16	Execution Error (Over Range, etc.)
3	8	None
2	4	Query Error
1	2	None
0	1	Operation Complete

This register is read by executing an “*ESR?” command per paragraph 11.5.1.2.2 (except no *). Note that this is a destructive read. Reading the register clears it. Each bit of the Event register must be enabled in order to cause the ESB bit of the Status Register to be set. This enabling is done in the Standard Event Status Enable Register by issuing an ESE command per paragraph 11.5.1.3.

Section 4: Theory

4.1 Introduction

The model 1910 Inductance Analyzer uses a principle of measurement which is based upon a technique developed by IET Labs. for its 7000 Series of Precision LCR Meters. In particular, the model 1910 employs digital techniques for signal generation and detection, as well as for the more usual data processing, user input output and remote communications functions. The following section provides a general overview of the model 1910 measurement technique for one familiar with impedance measurement and modern instrumentation. Subsequent sections provide detailed descriptions of operation, circuit block diagrams and system level control signals.

4.1.1 Description of 1910 Inductance Analyzer

In the model 1910 Inductance Analyzer, the voltage across the device under test (DUT) is measured, and the current through the DUT is measured across a reference resistor R_s which carries substantially the same current. The voltage across the DUT is E_x and the voltage across R_s is E_s . Both voltages are sampled many times per cycle of the applied sine wave excitation. E_x and E_s are essentially simultaneously sampled. There are five reference resistors in the 1910; the one used for a particular measurement is the optimal resistor for the device under test, frequency and amplitude of excitation. These characteristics are stored in the 1910 in non-volatile memory.

For both E_x and E_s a real and imaginary (in phase and quadrature) component are computed mathematically from the individual sample measurements. The real and imaginary components of E_x and E_s are with respect to a reference of arbitrary phase, so that by themselves they are meaningless. Any differences in the voltage and current detection and measurement process, as well as non-idealities in the sampling and digitization process, are corrected via software using calibration data. The real and imaginary components of E_x (E_{x_r} and E_{x_i}) are combined with the real and imaginary components of E_s (E_{s_r} and E_{s_i}) and the known characteristics of the reference resistor to determine the apparent complex impedance of the DUT using complex arithmetic.

Further calculations are made to remove the characteristics of the test fixture ("stray" capacitance and conductance and series resistance and inductance) if simple SHORT and OPEN calibration measurements have been made by the operator. These corrections are stored in non-volatile memory in the 1910 and are retained during power down and power up.

The detection and excitation circuitry is configured for each measurement by an embedded computer. For the excitation circuitry this includes frequency of excitation, DC bias current, and excitation level. Frequency is varied from 20Hz to 1MHz. Excitation level is between 20mV and 1V (open circuit).

For the detection circuitry this includes the reference resistor, the gain in the current and voltage detectors, and analog filtering optimized for the frequency of excitation. There are five reference resistors, each of which covers an impedance range of 15:1, and 5:1 at the lowest impedance. The reference resistor is normally chosen by the embedded computer to match the impedance of the unknown as closely as possible. However, the user may override this function, which can improve measurement speed in specialized applications. Gain in the voltage detector and current detector is normally chosen by the embedded computer to optimize the performance of the digitization process. The optimum gain in both detectors depends on excitation level, frequency and DUT impedance. As with the reference resistor, this can be overridden by the user.

The embedded computer also controls measurement speed. There are three settings for measurement accuracy: High (1 measurement per second), Medium (10 Measurements per second), and Low (40 measurements per second). These times can be lengthened somewhat depending on the frequency of excitation, averaging, median, and other conditions. The embedded computer also controls the local user interface (keyboard and display), and the remote interfaces (RS-232, IEEE-488 and handler interface).

A separate Digital Signal Processor (DSP) performs the high-speed calculations inherent in the measurement technique. The DSP computes the real and imaginary components of impedance, and converts these into Capacitance (C_s/C_p), Inductance (L_s/L_p), Resistance (R_s/R_p), Dissipation (DF) and Quality (Q) Factors, Impedance ($|Z|$), Admittance $|Y|$, Phase Angle (θ), Equivalent Series Resistance ($|ESR|$), Conductance (G_p), Reactance (X_s), Susceptance (B_p). Any two parameters can be measured and displayed simultaneously. In the above parameters the subscript s denotes series equivalent circuit, while subscript p denotes parallel equivalent circuit.

4.1.2 Block Diagram

The block diagram, Figure 4-1, shows the embedded computer connected via a CPU bus (B) composed of address, control and data lines to the other major functional blocks of the circuit.

The embedded computer includes the following types of memory: RAM for Program execution, FLASH for non-volatile program storage, EEROM for storage of calibration data, instrument configuration, and test setups.

The basic sine wave for excitation is generated in block (C). The embedded computer loads two values into block (C). The first value sets the basic frequency of the sine wave. The second value sets the frequency of the sampling pulse. The frequency of the sampling pulse is harmonically related to that of the sine wave. The generation process is described in section 4.2.2.

The sine wave is fed from block (C) to block (D), the power buffer. The embedded computer configures the power buffer to control the excitation level and voltage/current mode.

The final manipulation of the excitation signal is in block (E), bias control. The bias control block superimposes the AC excitation on a programmable DC bias current. The output of block (E) is connected to the IH terminal in section F for connection to the DUT.

Block (F), in addition to the IH line described above, contains three other coaxial connections to the DUT. PH and PL are the connections across the DUT that are used to measure the voltage across the DUT. IL is the connection that sinks the current sourced by IH. The current into IL is essentially exactly that in the DUT; the PH and PL connections are to high impedance circuitry and draw very little current. Any departure from ideal behavior is calibrated out digitally during the calibration process.

Block (G) is the circuitry which senses current and voltage and amplifies these signals for later processing. These signals are converted into digital streams of readings in block (H). In addition to the two analog signals from the voltage and current detectors, block (H) also has a sampling pulse signal that synchronizes the digitization process with the sine wave signal. The sampling pulse is generated in block (C). The digital stream of readings is fed into block (I) where they are combined to produce complex impedance, which is communicated to the embedded computer.

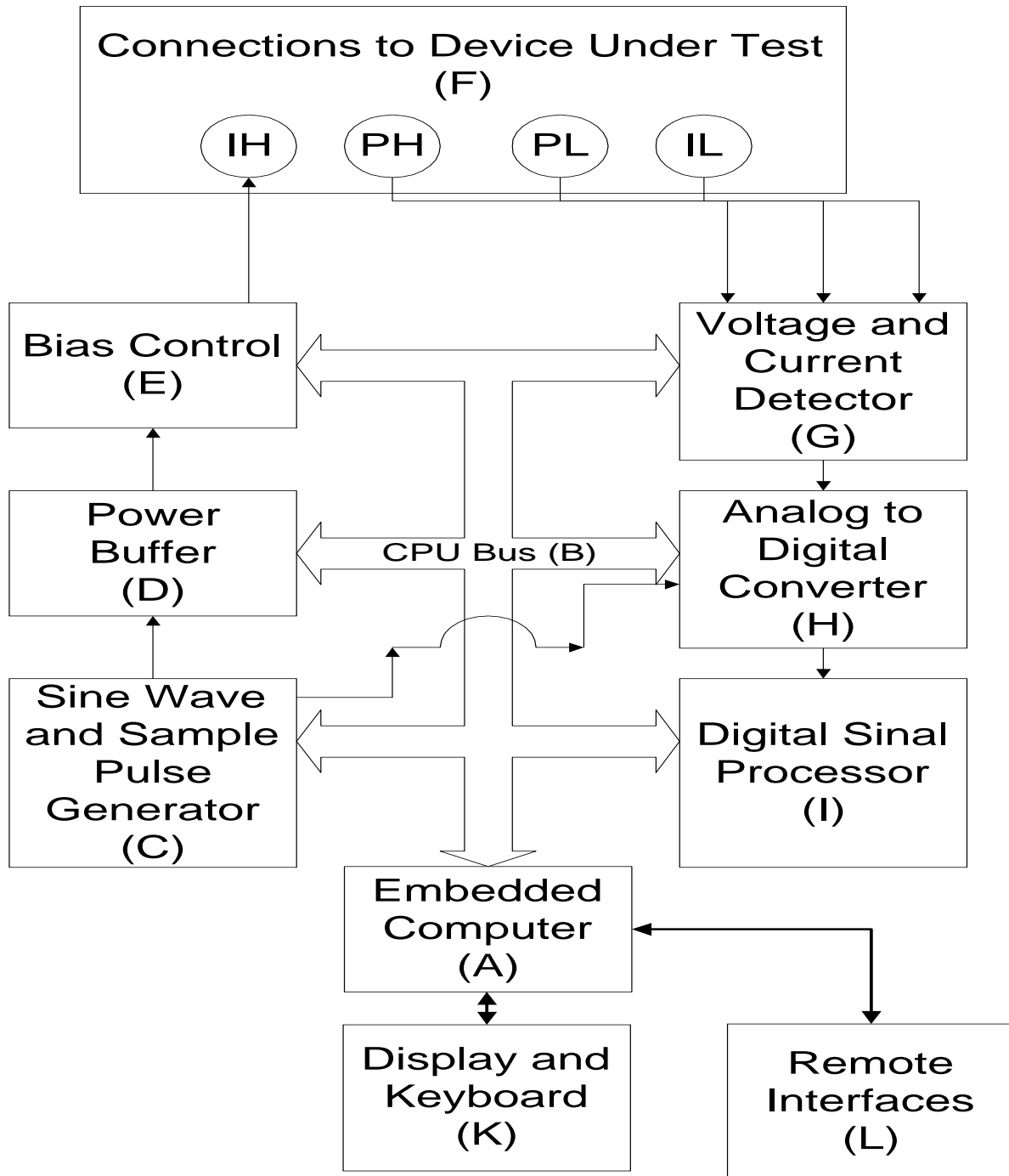

Figure 4-1: 1910 Instrument Block Diagram

4.2 Principal Functions

4.2.1 Fundamental Measurement

The fundamental measurement technique is illustrated as a simplified diagram in Figure 4-2. A sine wave generator drives current I_H through the DUT and a standard resistor in series. Two differential amplifiers with controlled gains produce voltages E_x and E_s . Simple algebra results in an expression for the complex impedance.

$$Z_x = R_s * (E_x/E_s)$$

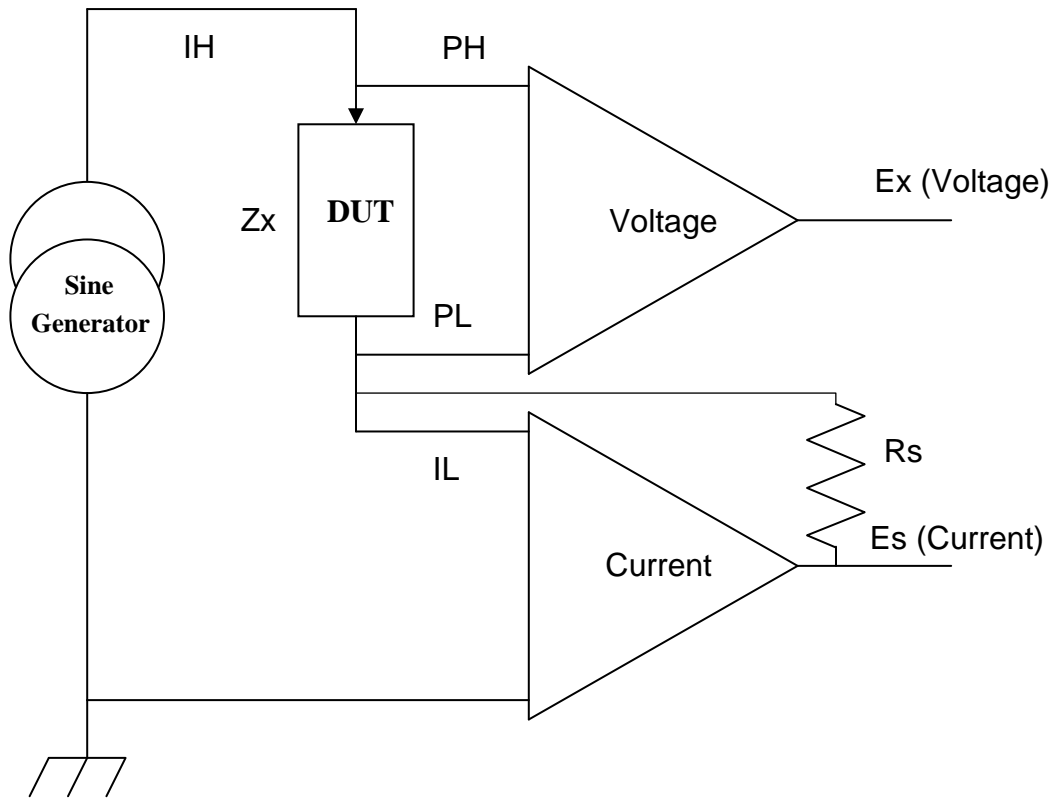

Figure 4-2: Fundamental Measurement

Notice that this ratio is complex. The embedded computer converts from the complex impedance Z_x to any of the available parameters, for example C and DF, mathematically.

4.2.2 Sine Wave and Sampling Pulse Generation

The direct digital sine wave synthesizer chips increment the phase of two sine waves internally at each clock cycle. The two sine wave signals are output from the chips differential analog signals. One of the outputs is as the signal source. The other output is filtered (low-pass) and connected to the comparator input of the DDS to create a sampling clock. The two phase increments are chosen so that the sampling pulse is in proper relationship with the sine wave.

4.2.3 Digitization

The digitization section consists of a simultaneously sampling two-channel analog to digital converter. The two samples are taken very nearly at the same time. Any delay of one channel relative to the other is calibrated out digitally during the calibration process.

Figures 4-3, 4-4 and 4-5 further illustrate the signal flow and test points within the 1910 Inductance Analyzer.

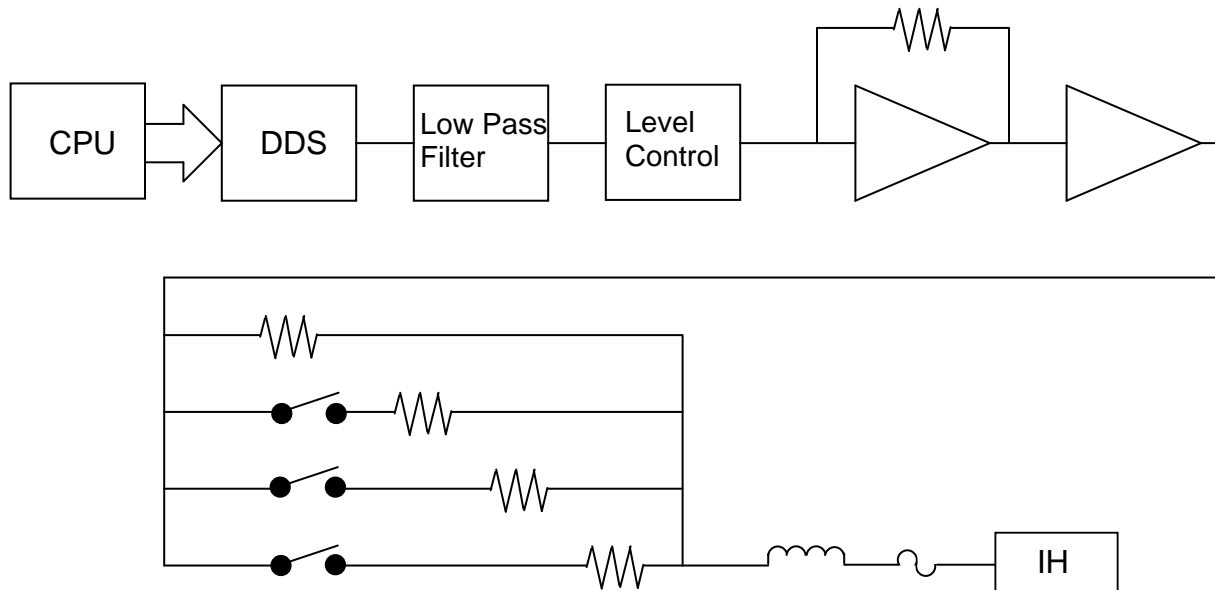

Figure 4-3: Signal Generation

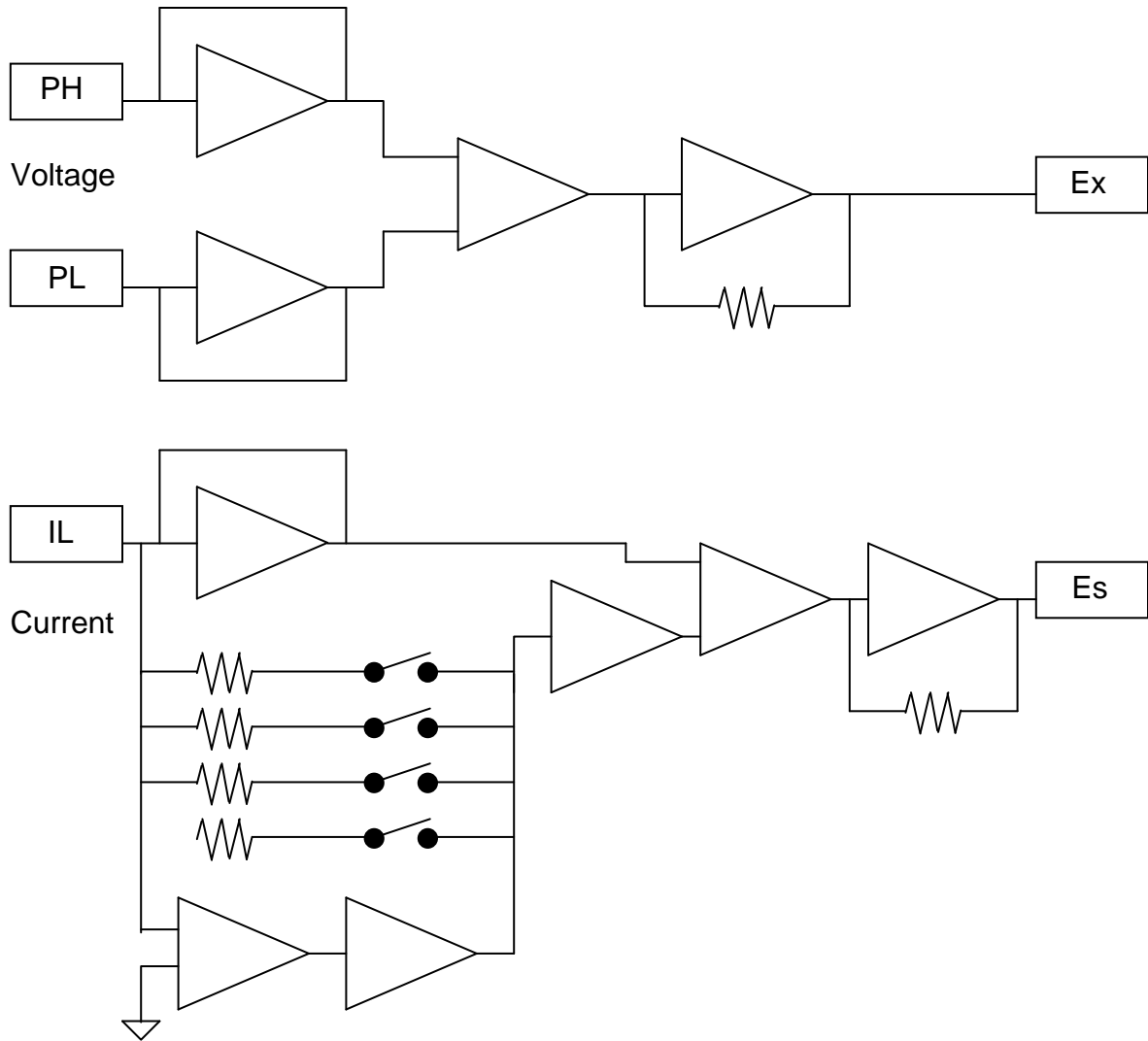

Figure 4-4: Detector Circuits

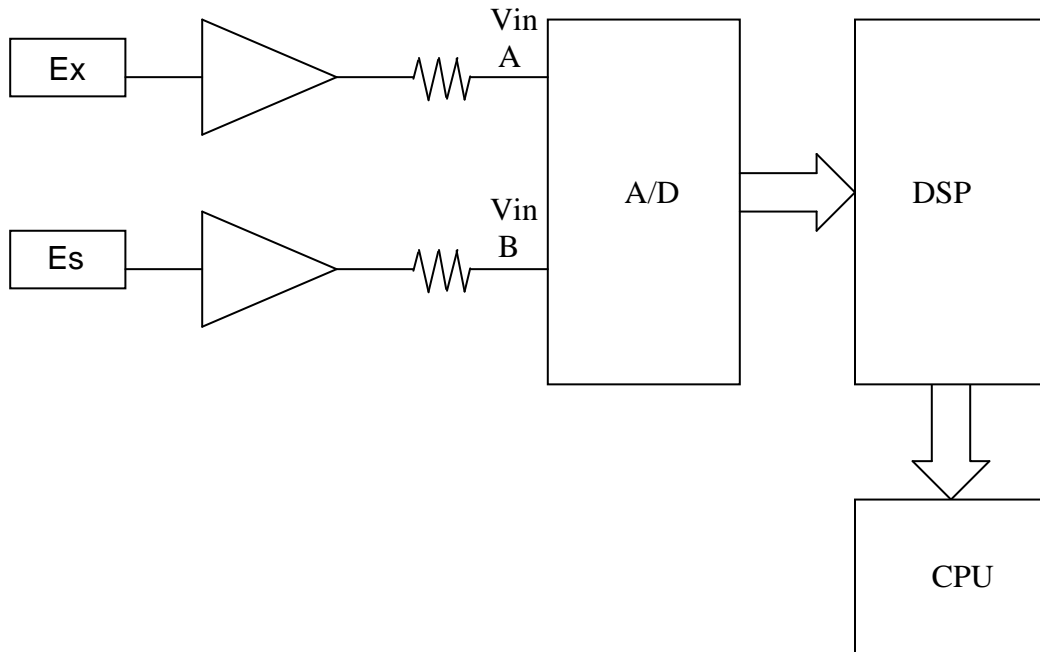

Figure 4-5: Digital Signal Processor

Section 5: Service & Calibration

5.1 General

Our warranty (at the front of this manual) attests to the quality of materials and workmanship in our products. If malfunction should be suspected or other information be desired, applications engineers are available for technical assistance. Application assistance is available in the U.S. by calling 800-253-1230 and asking for Applications Support. For support outside of the United States, please contact your local [IET Labs. Distributor](#).

5.2 Instrument Return

Before returning an instrument to IET Labs. for [Service](#) please obtain an [online Return Materials Authorization Number \(RMA#\)](#). This number, when placed on the outside of the shipping package, will speed processing at our Service Lab and will serve as a reference number for the time your unit is at IET Labs.. Please contact our **Customer Care Center (CCC)** at **800-253-1230** for additional support. The CCC phone line is staffed from 8:00am to 5:00pm (EST).

It will be necessary to include a Purchase Order Number and credit card information to insure expedient processing, although units found to be in warranty will be repaired at no-charge. For any questions on repair costs or shipment instructions please contact our CCC Department at the above number. To safeguard an instrument during storage and shipping please use packaging that is adequate to protect it from damage, i.e., equivalent to the original packaging and mark the box "Delicate Electronic Instrument". Please follow online instructions for shipping materials back to IET Labs..

5.3 Calibration

Calibration of the 1910 Inductance Analyzer is completed at the factory and includes a NIST calibration certificate. Verification of instrument operation and accuracy is recommended on an annual basis. Accurate operation of the 1910 instrument is confirmed using the following verification procedure.

5.3.1 1910 Verification Procedure

This section outlines the relevant information to verify performance of the 1910 Inductance Analyzer. It is recommended that performance be performed at least once a year using this outline procedure. Instrument should be warmed up for a minimum of 15 minutes prior to verification. Verification should be performed under the following conditions: Temperature equal to $23^{\circ}\text{C} \pm 1.2^{\circ}\text{C}$ and Relative Humidity (RH) between 35% and 55%.

Recommended standards are listed below. All standards should be traceable to a National Laboratory such as N.I.S.T. with calibrated values for primary and secondary parameters at the required test frequencies. IET Labs.'s verification conforms to ANSI Z540 and IET Labs. recommends that the calibrated values for the primary and secondary standards have an uncertainty 4 times better than the primary and secondary accuracy specified in the Verification Data Sheet. If the calibrated values for the standards used do not have an uncertainty of 4 times better than the specified accuracy of the 1910 the uncertainty of the standard should be added to the specified accuracy of the 1910. For example: if the calibrated value of the 500mΩ standard is 495.0mΩ ±1% at 1000Hz, the expected reading on the 1910 would be 495.0 mΩ ±1.327% (1% for the standard accuracy plus 0.327% for the 1910 accuracy). This also applies for secondary parameters as well.

Primary and secondary accuracy specifications given in the Verification Data Sheet are based upon the accuracy formulas in section 2.3.7 of this manual. Primary values are resistance, inductance and capacitance and secondary values are quality factor, quality factor and dissipation factor respectively.

Measurement Standards

Inductance Standards 4 Terminal

Inductor	10 μH (nominal value)
Inductor	100 μH (nominal value)
Inductor	1000 μH (nominal value)

Standard Open and Short

Resistance Standards 4 Terminal

Resistor	95K ohm (nominal value)
Resistor	6K ohm (nominal value)
Resistor	374 ohm (nominal value)
Resistor	25 ohm (nominal value)
Resistor	500m ohm (nominal value)

Capacitance Standards 2 or 4 Terminal

Capacitor	50pF (nominal value)
Capacitor	100pF (nominal value)
Capacitor	200pF (nominal value)
Capacitor	500pF (nominal value)
Capacitor	1000pF (nominal value)
Capacitor	0.1μF (nominal value)
Capacitor	0.05μF (nominal value)
Capacitor	0.02μF (nominal value)
Capacitor	0.01μF (nominal value)
Capacitor	0.002μF (nominal value)

Measurement Procedure

The 1910 should be set to the following:

[TEST CONDITIONS]

- Parameter = Automatic
- Frequency = Selected per data sheet below
- Amplitude = 1 Volt
- Bias Voltage = Off
- Measure Range = Auto
- Accuracy = High
- Delay = Off
- Averaging = 1
- Binning = Off

[UTILITY FUNCTIONS]

- Trigger Source = External
- Source Impedance = 25 ohms
- Cable Compensation = 1M
- Frequency Edit Type = Continuous

Connections to all standards should be via a 1-meter cable.

A multiple frequency open and short correction should be performed prior to any measurements. See paragraph 2.5.1 for information on performing an open and short correction.

Connect each standard listed in the Verification Data Sheet and select the test frequency on the 1910 as listed, see paragraph 2.3.3. Record the results in the Verification Data Sheet.

5.3.2 1910 Verification Data Sheet

R500M

Freq	Pri. Actual	Sec. Actual	Voltage	Primary Meas.	Sec. Meas. Q	Pspec	Sspec
1000			1			0.327%	0.0033
10000			1			0.327%	0.0033
100000			1			0.460%	0.0047

R25

Freq	Pri. Actual	Sec. Actual	Voltage	Primary Meas.	Sec. Meas. Q	Pspec	Sspec
1000			1			0.120%	0.0012
100000			1			0.166%	0.0017
1000000			1			0.644%	0.0065

R374

Freq	Pri. Actual	Sec. Actual	Voltage	Primary Meas.	Sec. Meas. Q	Pspec	Sspec
1000			1			0.116%	0.0012
100000			1			0.163%	0.0016
1000000			1			0.761%	0.0076

R6K

Freq	Pri. Actual	Sec. Actual	Voltage	Primary Meas.	Sec. Meas. Q	Pspec	Sspec
1000			1			0.117%	0.0012
10000			1			0.117%	0.0012
100000			1			0.196%	0.0020

R95.3K

Freq	Pri. Actual	Sec. Actual	Voltage	Primary Meas.	Sec. Meas. Q	Pspec	Sspec
100			1			0.196%	0.0020
1000			1			0.141%	0.0014
10000			1			0.141%	0.0015

L10uH

Freq	Pri. Actual	Sec. Actual	Voltage	Primary Meas.	Sec. Meas. Q	Pspec	Sspec
10000			1			0.384%	10.2285
100000			1			0.197%	37.8456
1000000			1			0.679%	5.8232

L100uH

Freq	Pri. Actual	Sec. Actual	Voltage	Primary Meas.	Sec. Meas. Q	Pspec	Sspec
1000			1			0.335%	0.372
100000			1			0.207%	60.2616
1000000			1			1.039%	66.2351

L1000uH

Freq	Pri. Actual	Sec. Actual	Voltage	Primary Meas.	Sec. Meas. Q	Pspec	Sspec
1000			1			0.477%	0.2389
10000			1			0.161%	5.0163
100000			1			0.177%	55.2771

C50pF

Freq	Pri. Actual	Sec. Actual	Voltage	Primary Meas.	Sec. Meas. Df	Pspec	Sspec
1000			1			0.959%	0.0109
100000			1			0.352%	0.0084
1000000			1			1.889%	0.1029

C100pF

Freq	Pri. Actual	Sec. Actual	Voltage	Primary Meas.	Sec. Meas. Df	Pspec	Sspec
1000			1			0.536%	0.0061
100000			1			0.256%	0.0060
1000000			1			1.248%	0.0678

C200pF

Freq	Pri. Actual	Sec. Actual	Voltage	Primary Meas.	Sec. Meas. Df	Pspec	Sspec
1000			1			0.326%	0.0037
100000			1			0.208%	0.0049
1000000			1			0.930%	0.0504

C500pF

Freq	Pri. Actual	Sec. Actual	Voltage	Primary Meas.	Sec. Meas. Df	Pspec	Sspec
1000			1			0.200%	0.0023
100000			1			0.179%	0.0042
1000000			1			0.739%	0.0400

C1000pF

Freq	Pri. Actual	Sec. Actual	Voltage	Primary Meas.	Sec. Meas. Df	Pspec	Sspec
1000			1			0.158%	0.0018
100000			1			0.170%	0.0040
1000000			1			0.677%	0.0366

C2nF

Freq	Pri. Actual	Sec. Actual	Voltage	Primary Meas.	Sec. Meas. Df	Pspec	Sspec
1000			1			0.137%	0.0015
100000			1			0.165%	0.0038
1000000			1			0.649%	0.0351

C10nF

Freq	Pri. Actual	Sec. Actual	Voltage	Primary Meas.	Sec. Meas. Df	Pspec	Sspec
1000			1			0.120%	0.0014
100000			1			0.162%	0.0038
1000000			1			0.654%	0.0354

C20nF

Freq	Pri. Actual	Sec. Actual	Voltage	Primary Meas.	Sec. Meas. Df	Pspec	Sspec
1000			1			0.118%	0.0013
100000			1			0.162%	0.0038
1000000			1			0.689%	0.0373

C50nF

Freq	Pri. Actual	Sec. Actual	Voltage	Primary Meas.	Sec. Meas. Df	Pspec	Sspec
1000			1			0.116%	0.0013
100000			1			0.165%	0.0038
1000000			1			0.802%	0.0436

C100nF

Freq	Pri. Actual	Sec. Actual	Voltage	Primary Meas.	Sec. Meas. Df	Pspec	Sspec
1000			1			0.116%	0.0013
100000			1			0.170%	0.0040
1000000			1			0.998%	0.0545

5.4 Diagnostics

5.4.1 Start-up Diagnostics

On start-up the unit displays step numbers during the initialization process. Should the display stop during this initialization the number displayed serves as a diagnostic tool. The numbers correspond to the following functions:

- (1) Verifies (initializes if necessary) cal data corresponding to No Cable (direction connection to the front panel).
- (2) Verifies (initializes if necessary) cal data corresponding to 1 M Cable.
- (3) Verifies (initializes if necessary) cal data corresponding to 2 M Cable.
- (4) Verifies (initializes if necessary) calibration kit data.
- (5) Verifies (initializes if necessary) test and step values.
- (6) Verifies (initializes if necessary) Utility setting and password.
- (7) Verifies (initializes if necessary) single tests.
- (8) Verifies (initializes if necessary) multi tests.
- (9) Booting the Digital Signal Processor (DSP)
- (10) Initialization complete

In case a problem should occur with the front panel display the Remote I/O bin outputs (1 thru 10) are also activated during this initialization process. Refer to paragraph 3.2 for the pin out of Bins 1 through 10.